



## TECHNICAL DATA

### MICROFAST® QUICK RESPONSE HORIZONTAL SIDEWALL SPRINKLER VK333 (K2.8)

The Viking Corporation, 210 N Industrial Park Drive, Hastings MI 49058

Telephone: 269-945-9501 Technical Services: 877-384-5464 Fax: 269-818-1680 Email: techsvcs@vikingcorp.com

Visit the Viking website for the latest edition of this technical data page [www.vikinggroupinc.com](http://www.vikinggroupinc.com).

#### 1. DESCRIPTION

The Viking Microfast® Quick Response Horizontal Sidewall Sprinkler VK333 is a small thermosensitive glass bulb spray sprinkler available with various finishes and temperature ratings to meet design requirements. The special Polyester and Electroless Nickel PTFE (ENT) coatings can be used in decorative applications where colors are desired. In addition, these coatings have been investigated for installation in corrosive environments and are listed/approved as indicated in the Approval Charts.

#### 2. LISTINGS AND APPROVALS

 cULus Listed: Category VNIV

Refer to Approval Chart 1 and Design Criteria for cULus Listing requirements that must be followed.

#### 3. TECHNICAL DATA

##### Specifications:

Minimum Operating Pressure: 7 psi (0.5 bar)  
Maximum Working Pressure: 175 psi (12 bar) wwp  
Factory tested hydrostatically to 500 psi (34.5 bar)  
Nominal K-Factor: 2.8 U.S. (40.3 metric\*)  
Thread size: 1/2" NPT, 15 mm BSPT

\* Metric K-factor measurement shown is when pressure is measured in Bar. When pressure is measured in kPa, divide the metric K-factor shown by 10.0.

Glass-bulb fluid temperature rated to -65 °F (-55 °C)  
Overall Length: 2-3/4" (68 mm)

##### Material Standards:

Frame Casting: Brass UNS-C84400  
Deflector: Copper UNS-C19500  
Bushing: Brass UNS-C36000  
Bulb: Glass, nominal 3 mm diameter  
Belleville Spring Sealing Assembly: Nickel Alloy, coated on both sides with PTFE Tape  
Screw: Brass UNS-C36000  
Pip Cap: Copper UNS-C11000 and Stainless Steel UNS-S30400  
For Polyester Coated Sprinklers: Belleville Spring-Exposed  
For ENT Coated Sprinklers: Belleville Spring-Exposed, Screw and Pip Cap ENT Plated

##### Ordering Information: (Also refer to the current Viking price list.)

Order Viking Microfast® Quick Response Horizontal Sidewall Sprinkler VK333 by first adding the appropriate suffix for the sprinkler finish and then the appropriate suffix for the temperature rating to the sprinkler base part number.

Finish Suffix: Brass = A, Chrome = F, White Polyester = M-/W, Black Polyester = M-/B, and ENT = JN  
Temperature Suffix (°F/°C): 135°/57° = A, 155°/68° = B, 175°/79° = D, 200°/93° = E, and 286°/141° = G

For example, sprinkler VK333 with a Brass finish and a 155 °F/68 °C temperature rating = Part No. 10035AB

##### Available Finishes And Temperature Ratings: Refer to Table 1.

##### Accessories: (Also refer to the Viking website.)

##### Sprinkler Wrenches:

- A. Standard Wrench: Part No. 21475M/B (available since 2017).
  - B. Wrench for recessed sprinklers with protective shields: Part No. 13655W/B\*\* (available since 2003)
- \*\*A 1/2" ratchet is required (not available from Viking).

##### Sprinkler Cabinets:

- A. Six-head capacity: Part No. 01724A (available since 1971)
- B. Twelve-head capacity: Part No. 01725A (available since 1971)

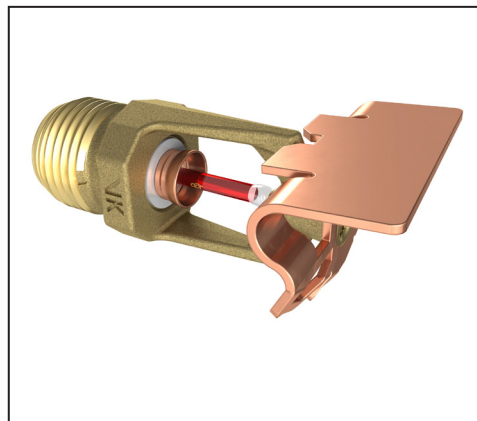

For Light Hazard Occupancies Only

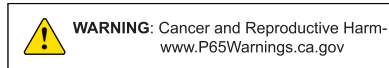



## TECHNICAL DATA

### MICROFAST® QUICK RESPONSE HORIZONTAL SIDEWALL SPRINKLER VK333 (K2.8)

The Viking Corporation, 210 N Industrial Park Drive, Hastings MI 49058

Telephone: 269-945-9501 Technical Services: 877-384-5464 Fax: 269-818-1680 Email: techsvcs@vikingcorp.com

Visit the Viking website for the latest edition of this technical data page [www.vikinggroupinc.com](http://www.vikinggroupinc.com).

#### 4. INSTALLATION

Refer to appropriate NFPA Installation Standards.

#### 5. OPERATION

During fire conditions, the heat-sensitive liquid in the glass bulb expands, causing the glass to shatter, releasing the pip cap and sealing spring assembly. Water flowing through the sprinkler orifice strikes the sprinkler deflector, forming a uniform spray pattern to extinguish or control the fire.

#### 6. INSPECTIONS, TESTS AND MAINTENANCE

Refer to NFPA 25 for Inspection, Testing and Maintenance requirements.

#### 7. AVAILABILITY

Viking Microfast® Quick Response Horizontal Sidewall Sprinkler VK333 are available through a network of domestic and international distributors. See The Viking Corporation web site for the closest distributor or contact The Viking Corporation.

#### 8. GUARANTEE

For details of warranty, refer to Viking's current list price schedule or contact Viking directly.

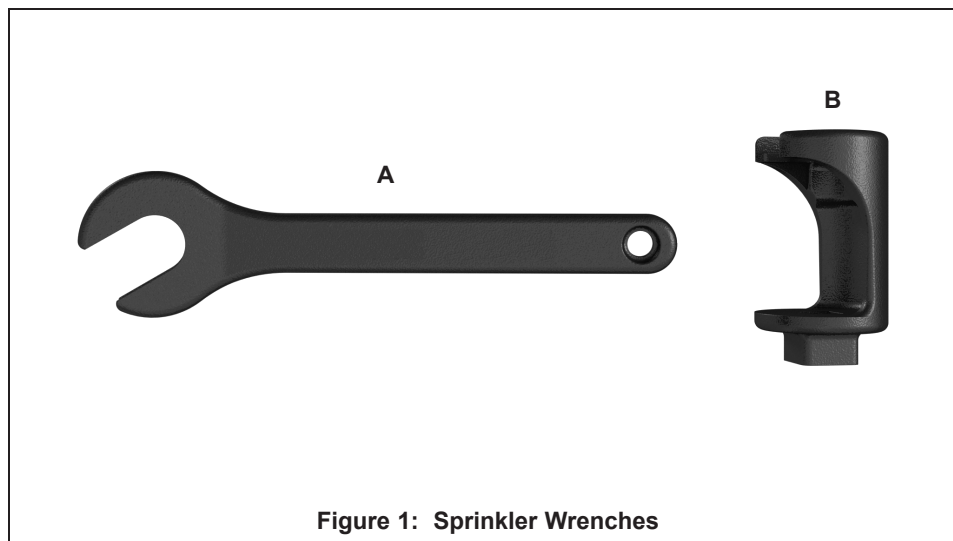

Figure 1: Sprinkler Wrenches



**TECHNICAL DATA**

**MICROFAST® QUICK  
RESPONSE HORIZONTAL  
SIDEWALL SPRINKLER  
VK333 (K2.8)**

The Viking Corporation, 210 N Industrial Park Drive, Hastings MI 49058  
 Telephone: 269-945-9501 Technical Services: 877-384-5464 Fax: 269-818-1680 Email: techsvcs@vikingcorp.com  
 Visit the Viking website for the latest edition of this technical data page www.vikinggroupinc.com.

**TABLE 1: AVAILABLE SPRINKLER TEMPERATURE RATINGS AND FINISHES**

Sprinkler Temperature Classification	Sprinkler Nominal Temperature Rating <sup>1</sup>	Maximum Ambient Ceiling Temperature <sup>2</sup>	Bulb Color
Ordinary	135 °F (57 °C)	100 °F (38 °C)	Orange
Ordinary	155 °F (68 °C)	100 °F (38 °C)	Red
Intermediate	175 °F (79 °C)	150 °F (65 °C)	Yellow
Intermediate	200 °F (93 °C)	150 °F (65 °C)	Green
High	286 °F (141 °C)	225 °F (107 °C)	Blue

**Sprinkler Finishes:** Brass, Chrome, White Polyester, Black Polyester, and ENT

**Corrosion-Resistant Coatings<sup>3</sup>:** White Polyester, Black Polyester, and ENT

**Footnotes**

- <sup>1</sup> The sprinkler temperature rating is stamped on the deflector.
- <sup>2</sup> Based on NFPA-13. Other limits may apply, depending on fire loading, sprinkler location, and other requirements of the Authority Having Jurisdiction. Refer to specific installation standards.
- <sup>3</sup> The corrosion resistant coatings have passed the standard corrosion test required by the approving agencies indicated in the Approval Chart(s). These tests cannot and do not represent all possible corrosive environments. Prior to installation, verify through the end-user that the coatings are compatible with or suitable for the proposed environment. For automatic sprinklers, the coatings indicated are applied to the exposed exterior surfaces only. Note that the spring is exposed on sprinklers with Polyester and ENT coatings. For ENT coated automatic sprinklers, the waterway is coated.

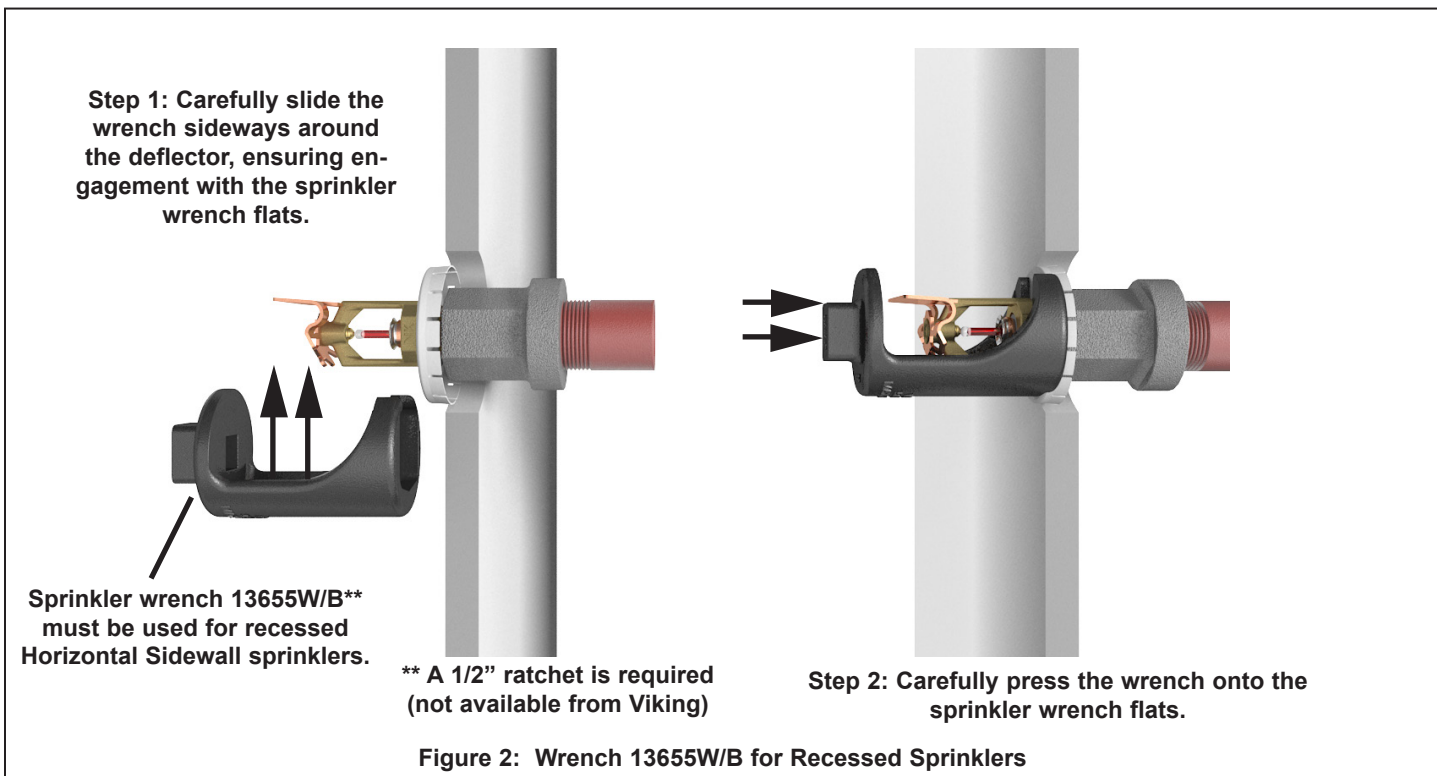

	<h2 style="margin: 0;">TECHNICAL DATA</h2>	<h3 style="margin: 0;">MICROFAST® QUICK RESPONSE HORIZONTAL SIDEWALL SPRINKLER VK333 (K2.8)</h3>
---	--	--

**The Viking Corporation, 210 N Industrial Park Drive, Hastings MI 49058**  
**Telephone: 269-945-9501 Technical Services: 877-384-5464 Fax: 269-818-1680 Email: techsvcs@vikingcorp.com**  
**Visit the Viking website for the latest edition of this technical data page www.vikinggroupinc.com.**

<b>Approval Chart 1 (UL)</b> Microfast® Quick Response Horizontal Sidewall Sprinkler VK333 for light hazard occupancies only deflector must be located 4" to 6" (102 mm to 152 mm) below the ceiling.												
Base Part Number <sup>1</sup>	SIN	Maximum Pressure	Thread Size		Nominal K-Factor		Overall Length		Listings and Approvals <sup>3</sup> (Refer also to Design Criteria below.)			
			NPT	BSPT	U.S.	metric <sup>2</sup>	Inches	mm	cULus <sup>4</sup>	LPCB	CE	UL
209897	VK333	250 psi	1/2"	15 mm	2.8	40.3	2-11/16	68	A1Y, B1X, C2Y, D2Z	--	--	--
<b>Approved Temperature Ratings</b> A - 135 °F (57 °C), 155 °F (68 °C), 175 °F (79 °C), 200 °F (93 °C), and 286 °F (141 °C) B - 135 °F (57 °C), 155 °F (68 °C), 175 °F (79 °C), and 200 °F (93 °C) C - 155 °F (68 °C), 175 °F (79 °C), 200 °F (93 °C), and 286 °F (141 °C) D - 155 °F (68 °C), 175 °F (79 °C), and 200 °F (93 °C)					<b>Approved Finishes</b> 1 - Brass, Chrome, White Polyester <sup>5,6</sup> , and Black Polyester <sup>5,6</sup> 2 - ENT <sup>5</sup>			<b>Approved Escutcheons</b> X - Installed with standard surface-mounted escutcheons or recessed with the Viking Micromatic® Model E-1, E-2, E-3, or G-1 Recessed Escutcheon Y - Installed with standard surface-mounted escutcheons Z - Installed with standard surface-mounted escutcheons or recessed with the Viking Micromatic® Model E-1 Recessed Escutcheon				
<b>Footnotes</b> <sup>1</sup> Base part number shown. For complete part number, refer to Viking's current price schedule. <sup>2</sup> Metric K-factor measurement shown is when pressure is measured in Bar. When pressure is measured in kPa, divide the metric K-factor shown by 10.0. <sup>3</sup> This table shows the listings and approvals available at the time of printing. Other approvals may be in process. <sup>4</sup> Listed by Underwriters Laboratories Inc. for use in the U.S. and Canada. <sup>5</sup> cULus Listed as corrosion-resistant. <sup>6</sup> Other colors are available on request with the same Listings and Approvals as the standard colors. <sup>7</sup> Listings are limited to Light Hazard Occupancies, with hydraulically calculated wet systems. exception: 4.2K sprinklers may be installed on hydraulically calculated dry pipe systems where piping is corrosion resistant or internally galvanized.												

<b>DESIGN CRITERIA - UL</b> (Also refer to Approval Chart 1 above.)
<p><b>cULus Listing Requirements:</b></p> <p>Viking Microfast® Quick Response Horizontal Sidewall Sprinkler VK333 is cULus Listed as indicated in the Approval Chart for installation in accordance with the latest edition of NFPA 13 for sidewall standard spray sprinklers.</p> <ul style="list-style-type: none"> <li>• Limited to Light Hazard occupancies only (<i>Small orifice sprinklers are limited to Light Hazard where allowed by the installation standards being applied, with hydraulically calculated wet systems only.</i>)</li> <li>• Protection areas and maximum spacing shall be in accordance with the tables provided in NFPA 13. Minimum spacing allowed is 6 ft. (1.8 m).</li> <li>• Locate the deflector 4" to 6" (102 mm to 152 mm) below the ceiling. Align with the leading edge of the deflector parallel to the ceiling.</li> <li>• Maximum distance from end walls shall be no more than one-half of the allowable distance between sprinklers. The distance shall be measured perpendicular to the wall. Minimum distance from end walls is 4 in. (102 mm).</li> <li>• The sprinkler installation and obstruction rules contained in NFPA 13 for sidewall standard spray sprinklers must be followed.</li> </ul> <p><b>IMPORTANT: Always refer to Bulletin Form No. F_091699 - Care and Handling of Sprinklers. Also refer to page QR1-3 for general care, installation, and maintenance information. Viking sprinklers are to be installed in accordance with the latest edition of Viking technical data, the appropriate standards of NFPA, LPCB, APSAD, VdS or other similar organizations, and also with the provisions of governmental codes, ordinances, and standards, whenever applicable.</b></p>



**TECHNICAL DATA**

**MICROFAST® QUICK  
RESPONSE HORIZONTAL  
SIDEWALL SPRINKLER  
VK333 (K2.8)**

The Viking Corporation, 210 N Industrial Park Drive, Hastings MI 49058

Telephone: 269-945-9501 Technical Services: 877-384-5464 Fax: 269-818-1680 Email: techsvcs@vikingcorp.com

Visit the Viking website for the latest edition of this technical data page [www.vikinggroupinc.com](http://www.vikinggroupinc.com).

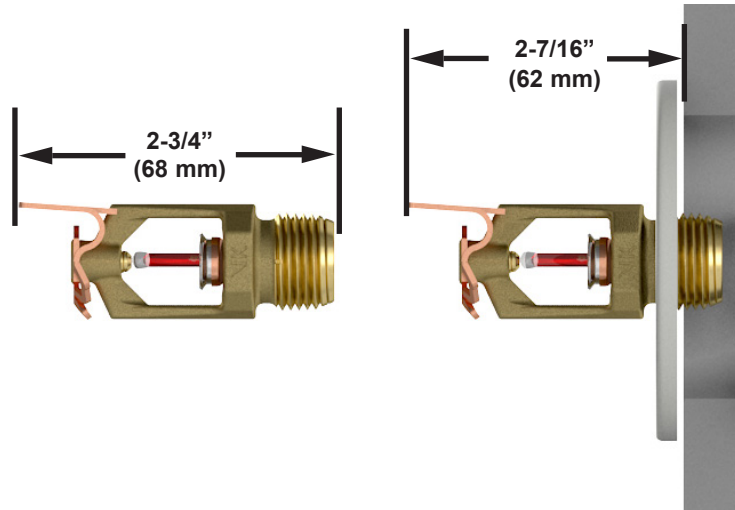

**Wall Opening Size:**  
2-5/16" (59 mm) minimum  
2-1/2" (64 mm) maximum

**Installed with a Standard  
1/8" Surface-Mounted  
Escutcheon**

**Figure 3: Horizontal Sidewall Sprinkler Dimensions with a Standard Escutcheon**

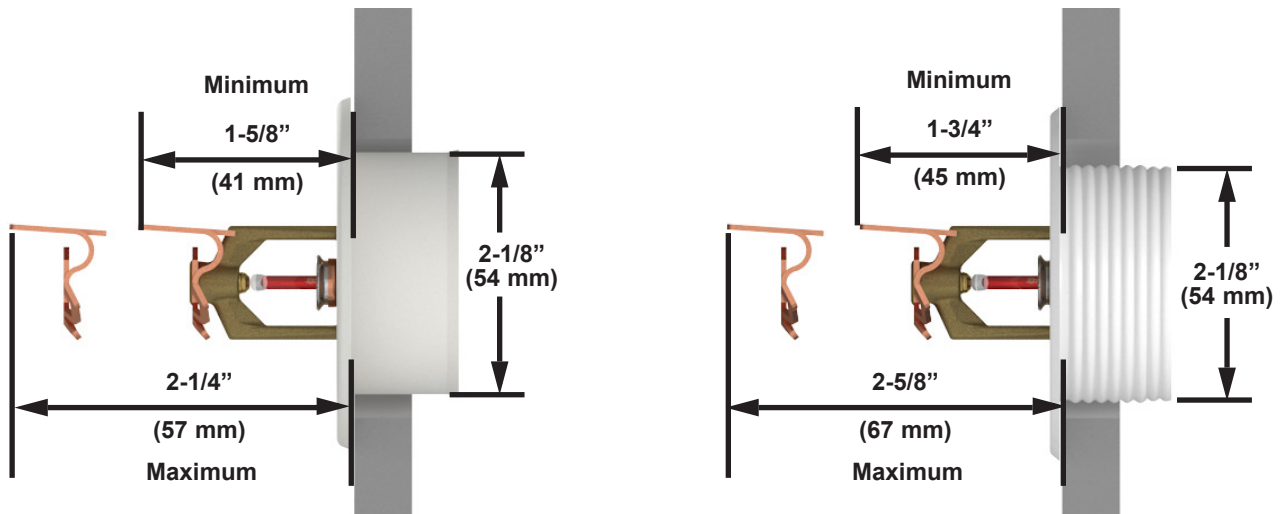

**Wall Opening Size:**  
2-5/16" (59 mm) minimum  
2-1/2" (64 mm) maximum

**Installed with the  
Micromatic Model E-1  
Recessed Escutcheon**

**Installed with the  
Threaded Model E-2  
Recessed Escutcheon**

**Figure 4: Horizontal Sidewall Sprinkler Dimensions with the Model E-1 and E-2 Recessed Escutcheons**



**TECHNICAL DATA**

**MICROFAST® QUICK  
RESPONSE HORIZONTAL  
SIDEWALL SPRINKLER  
VK333 (K2.8)**

The Viking Corporation, 210 N Industrial Park Drive, Hastings MI 49058

Telephone: 269-945-9501 Technical Services: 877-384-5464 Fax: 269-818-1680 Email: techsvcs@vikingcorp.com

Visit the Viking website for the latest edition of this technical data page [www.vikinggroupinc.com](http://www.vikinggroupinc.com).

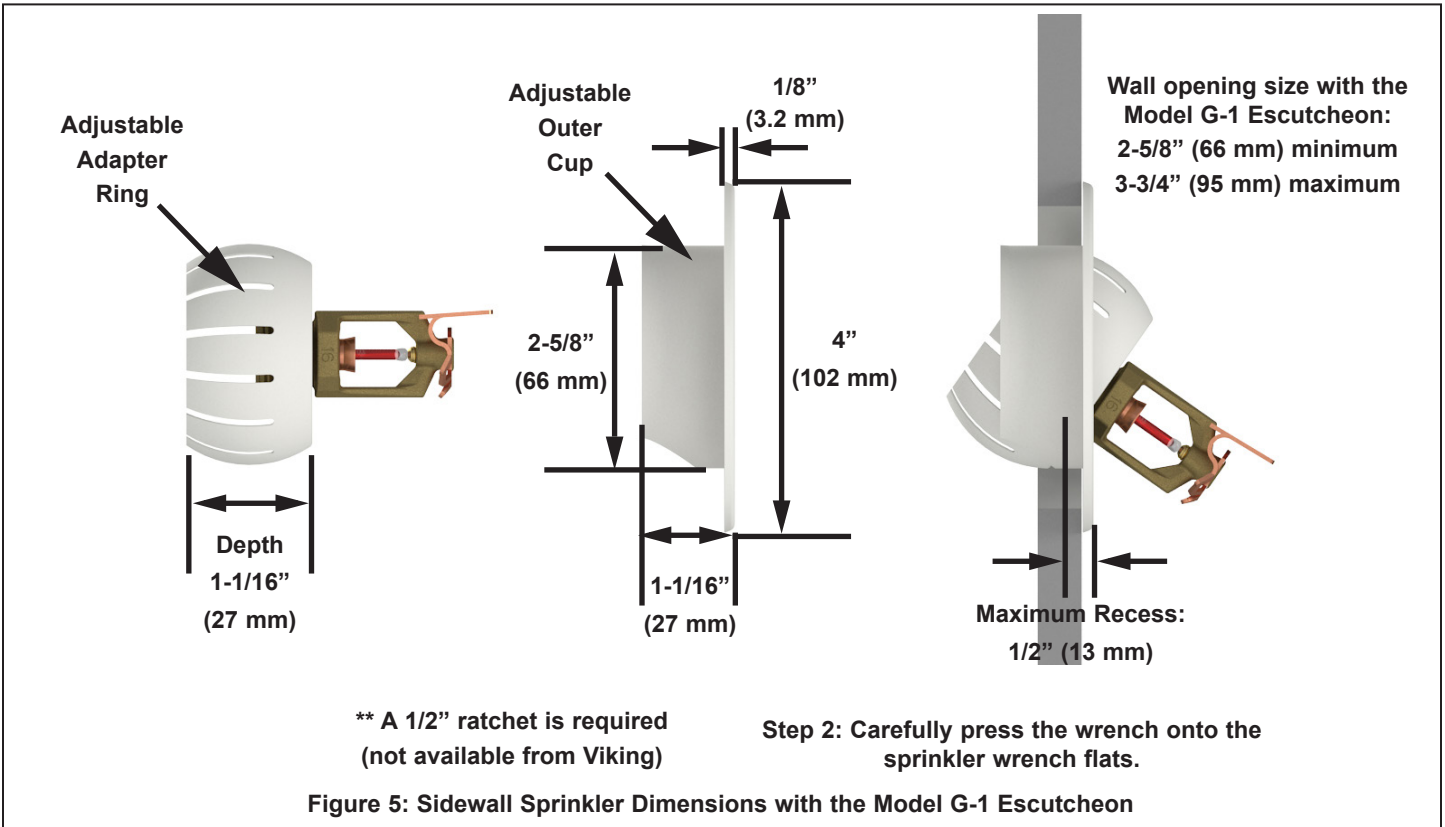



**BULLETIN**

**CARE AND HANDLING OF SPRINKLERS**

The Viking Corporation, 210 N Industrial Park Drive, Hastings MI 49058  
 Telephone: 269-945-9501 Technical Services: 877-384-5464 Fax: 269-818-1680 Email: techsvcs@vikingcorp.com

**SPRINKLERS ARE FRAGILE - HANDLE WITH CARE!**

**General Handling and Storage:**

- Store sprinklers in a cool, dry place.
- Protect sprinklers during storage, transport, handling, and after installation.
- Use the original shipping containers. DO NOT place sprinklers loose in boxes, bins, or buckets.
- Keep sprinklers separated at all times. DO NOT allow metal parts to contact sprinkler operating elements.

**For Pre-Assembled Drops:**

- Protect sprinklers during handling and after installation.
- For recessed assemblies, use the protective sprinkler cap (Viking Part Number 10364).

**Sprinklers with Protective Shields or Caps:**

- DO NOT remove shields or caps until after sprinkler installation and there no longer is potential for mechanical damage to the sprinkler operating elements.
- **Sprinkler shields or caps MUST be removed BEFORE placing the system in service!**
- Remove the sprinkler shield by carefully pulling it apart where it is snapped together.
- Remove the cap by turning it slightly and pulling it off the sprinkler.

**Sprinkler Installation:**

- DO NOT use the sprinkler deflector or operating element to start or thread the sprinkler into a fitting.
- **Use only the designated sprinkler head wrench!** Refer to the current sprinkler technical data page to determine the correct wrench for the model of sprinkler used.
- DO NOT install sprinklers onto piping at the floor level.
- Install sprinklers after the piping is in place to prevent mechanical damage.
- DO NOT allow impacts such as hammer blows directly to sprinklers or to fittings, pipe, or couplings in close proximity to sprinklers. Sprinklers can be damaged from direct or indirect impacts.
- DO NOT attempt to remove drywall, paint, etc., from sprinklers.
- **Take care not to over-tighten the sprinkler and/or damage its operating parts!**

**Maximum Torque:**

- 1/2" NPT: 14 ft-lbs. (19.0 N-m)**
- 3/4" NPT: 20 ft-lbs. (27.1 N-m)**
- 1" NPT: 30 ft-lbs. (40.7 N-m)**



**CORRECT**  
(Original container used)

**INCORRECT**  
(Placed loose in box)

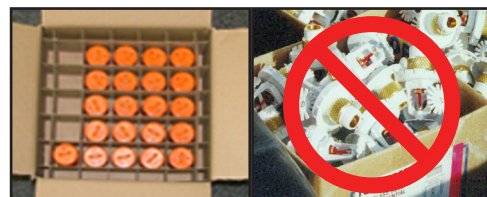

**CORRECT**  
(Protected with caps)

**INCORRECT**  
(Protective caps not used)



**CORRECT**  
(Piping is in place at the ceiling)

**INCORRECT**  
(Sprinkler at floor level)



**CORRECT**  
(Special installation wrenches)

**INCORRECT**  
(Designated wrench not used)

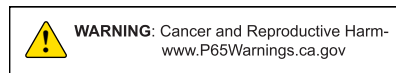

**! WARNING**

Any sprinkler with a loss of liquid from the glass bulb or damage to the fusible element should be destroyed. Never install sprinklers that have been dropped, damaged, or exposed to temperatures exceeding the maximum ambient temperature allowed. Sprinklers that have been painted in the field must be replaced per NFPA 13. Protect sprinklers from paint and paint overspray in accordance with the installation standards. Do not clean sprinklers with soap and water, ammonia, or any other cleaning fluid. Do not use adhesives or solvents on sprinklers or their operating elements.

**Refer to the appropriate technical data page and NFPA standards for complete care, handling, installation, and maintenance instructions. For additional product and system information Viking data pages and installation instructions are available on the Viking Web site at [www.vikinggroupinc.com](http://www.vikinggroupinc.com).**



## BULLETIN

CARE AND HANDLING  
OF SPRINKLERS

The Viking Corporation, 210 N Industrial Park Drive, Hastings MI 49058  
 Telephone: 269-945-9501 Technical Services: 877-384-5464 Fax: 269-818-1680 Email: techsvcs@vikingcorp.com

## PROTECTIVE SPRINKLER SHIELDS AND CAPS

### General Handling and Storage:

Many Viking sprinklers are available with a plastic protective cap or shield temporarily covering the operating elements. The snap-on shields and caps are factory installed and are intended to help protect the operating elements from mechanical damage during shipping, storage, and installation. NOTE: It is still necessary to follow the care and handling instructions on the appropriate sprinkler technical data sheets\* when installing sprinklers with bulb shields or caps.

### WHEN TO REMOVE THE SHIELDS AND CAPS:

NOTE: SHIELDS AND CAPS MUST BE REMOVED FROM SPRINKLERS BEFORE PLACING THE SYSTEM IN SERVICE!

Remove the shield or cap from the sprinkler only after checking all of the following:

- The sprinkler has been installed\*.
- The wall or ceiling finish work is completed where the sprinkler is installed and there no longer is a potential for mechanical damage to the sprinkler operating elements.

**SHIELDS AND CAPS MUST BE REMOVED FROM SPRINKLERS BEFORE PLACING THE SYSTEM IN SERVICE!**



Figure 1: Sprinkler shield being removed from a pendent sprinkler.



Figure 2: Sprinkler cap being removed from a pendent sprinkler.



Figure 3: Sprinkler cap being removed from an upright sprinkler.

## HOW TO REMOVE SHIELDS AND CAPS:

No tools are necessary to remove the shields or caps from sprinklers. DO NOT use any sharp objects to remove them! **Take care not to cause mechanical damage to sprinklers when removing the shields or caps.** When removing caps from fusible element sprinklers, use care to prevent dislodging ejector springs or damaging fusible elements. NOTE: Squeezing the sprinkler cap excessively could damage sprinkler fusible elements.

- To remove the shield, simply pull the ends of the shield apart where it is snapped together. Refer to Figure 1.
- To remove the cap, turn it slightly and pull it off the sprinkler. Refer to Figures 2 and 3.

### NOTICE

Refer to the current sprinkler technical data page to determine the correct sprinkler wrench for the model of sprinkler used.

### WARNING

Never install sprinklers that have been dropped, damaged, or exposed to temperatures in excess of the maximum ambient temperature allowed.

\* Refer to the appropriate current technical data pages for complete care, handling, and installation instructions. Data pages are included with each shipment from Viking or Viking distributors. They can also be found on the Web site at [www.vikinggroupinc.com](http://www.vikinggroupinc.com).





## BULLETIN

CARE AND HANDLING  
OF SPRINKLERS

The Viking Corporation, 210 N Industrial Park Drive, Hastings MI 49058  
 Telephone: 269-945-9501 Technical Services: 877-384-5464 Fax: 269-818-1680 Email: techsvcs@vikingcorp.com



**CONCEALED COVER ASSEMBLIES ARE FRAGILE!**  
**TO ASSURE SATISFACTORY PERFORMANCE OF THE PRODUCT, HANDLE WITH CARE.**



Concealed Sprinkler and Adapter  
 Assembly with Protective Cap

Concealed Sprinkler and Adapter  
 Assembly (Protective Cap Removed)



Cover Plate Assembly  
 (Pendent Cover 12381 shown)



#### GENERAL HANDLING AND STORAGE INSTRUCTIONS:

- Do not store in temperatures exceeding 100 °F (38 °C). Avoid direct sunlight and confined areas subject to heat.
- Protect sprinklers and cover assemblies during storage, transport, handling, and after installation.
  - Use original shipping containers.
  - Do not place sprinklers or cover assemblies loose in boxes, bins, or buckets.
- Keep the sprinkler bodies covered with the protective sprinkler cap any time the sprinklers are shipped or handled, during testing of the system, and while ceiling finish work is being completed.
- Use only the designated Viking recessed sprinkler wrench (refer to the appropriate sprinkler data page) to install these sprinklers. **NOTE:** The protective cap is temporarily removed during installation and then placed back on the sprinkler for protection until finish work is completed.
- Do not over-tighten the sprinklers into fittings during installation.
- Do not use the sprinkler deflector to start or thread the sprinklers into fittings during installation.
- Do not attempt to remove drywall, paint, etc., from the sprinklers.
- Remove the plastic protective cap from the sprinkler before attaching the cover plate assembly. **PROTECTIVE CAPS MUST BE REMOVED FROM SPRINKLERS BEFORE PLACING THE SYSTEM IN SERVICE!**

Refer to the appropriate current technical data pages for complete care, handling, and installation instructions. Data pages are included with each shipment from Viking or Viking distributors. They can also be found on the Web site at [www.vikinggroupinc.com](http://www.vikinggroupinc.com).



## BULLETIN

CARE AND HANDLING  
OF SPRINKLERS

The Viking Corporation, 210 N Industrial Park Drive, Hastings MI 49058

Telephone: 269-945-9501 Technical Services: 877-384-5464 Fax: 269-818-1680 Email: techsvcs@vikingcorp.com

## USE THE FOLLOWING PRECAUTIONS WHEN HANDLING WAX-COATED SPRINKLERS

Many of Viking's sprinklers are available with factory-applied wax coating for corrosion resistance. These sprinklers MUST receive appropriate care and handling to avoid damaging the wax coating and to assure satisfactory performance of the product.

### General Handling and Storage of Wax-Coated Sprinklers:

- Store the sprinklers in a cool, dry place (in temperatures below the maximum ambient temperature allowed for the sprinkler temperature rating. Refer to Table 1 below.)
- Store containers of wax-coated sprinklers separate from other sprinklers.
- Protect the sprinklers during storage, transport, handling, and after installation.
- Use original shipping containers.
- Do not place sprinklers in loose boxes, bins, or buckets.

### Installation of Wax-Coated Sprinklers:

Use only the special sprinkler head wrench designed for installing wax-coated Viking sprinklers (any other wrench may damage the unit).

- Take care not to crack the wax coating on the units.
- For touching up the wax coating after installation, wax is available from Viking in bar form. Refer to Table 1 below. The coating MUST be repaired after sprinkler installation to protect the corrosion-resistant properties of the sprinkler.
- Use care when locating sprinklers near fixtures that can generate heat. Do not install sprinklers where they would be exposed to temperatures exceeding the maximum recommended ambient temperature for the temperature rating used.
- Inspect the coated sprinklers frequently soon after installation to verify the integrity of the corrosion resistant coating. Thereafter, inspect representative samples of the coated sprinklers in accordance with NFPA 25. Close up visual inspections are necessary to determine whether the sprinklers are being affected by corrosive conditions.

TABLE 1

Sprinkler Temperature Rating (Fusing Point)	Wax Part Number	Wax Melting Point	Maximum Ambient Ceiling Temperature <sup>1</sup>	Wax Color
155 °F (68 °C) / 165 °F (74 °C)	02568A	148 °F (64 °C)	100 °F (38 °C)	Light Brown
175 °F (79 °C)	04146A	161 °F (71 °C)	150 °F (65 °C)	Brown
200 °F (93 °C)	04146A	161 °F (71 °C)	150 °F (65 °C)	Brown
220 °F (104 °C)	02569A	170 °F (76 °C)	150 °F (65 °C)	Dark Brown
286 °F (141 °C)	02569A	170 °F (76 °C)	150 °F (65 °C)	Dark Brown

<sup>1</sup> Based on NFPA-13. Other limits may apply, depending on fire loading, sprinkler location, and other requirements of the Authority Having Jurisdiction. Refer to specific installation standards.



Never install sprinklers that have been dropped, damaged, or exposed to temperatures in excess of the maximum ambient temperature allowed.

Refer to the appropriate current technical data pages for complete care, handling, and installation instructions. Data pages are included with each shipment from Viking or Viking distributors. They can also be found on the Web site at [www.vikinggroupinc.com](http://www.vikinggroupinc.com).

**BULLETIN****REGULATORY AND HEALTH  
WARNINGS**

The Viking Corporation, 210 N Industrial Park Drive, Hastings MI 49058

Telephone: 269-945-9501 Technical Services: 877-384-5464 Fax: 269-818-1680 Email: [techsvcs@vikingcorp.com](mailto:techsvcs@vikingcorp.com)

Visit the Viking website for the latest edition of this technical data page [www.vikinggroupinc.com](http://www.vikinggroupinc.com)

**1. DESCRIPTION**

Regulatory and Health Warnings applying to materials used in the manufacture and construction of fire protection products are provided herein as they relate to legally mandated jurisdictional regions.

**⚠ WARNING****STATE OF CALIFORNIA, USA**

Installing or servicing fire protection products such as sprinklers, valves, piping etc. can expose you to chemicals including, but not limited to, lead, nickel, butadiene, titanium dioxide, chromium, carbon black, and acrylonitrile which are known to the State of California to cause cancer or birth defects or other reproductive harm.

For more information, go to [www.P65Warnings.ca.gov](http://www.P65Warnings.ca.gov)

**2. WARRANTY TERMS AND CONDITIONS**

For details of warranty, refer to Viking's current list price schedule at [www.vikinggroupinc.com](http://www.vikinggroupinc.com) or contact Viking directly.