

HIGH VELOCITY WATER SPRAY NOZZLE (BRASS)



TECHNICAL DATA

| | | |
|---|--|----------------------|
| MODEL | HV-AS with strainer | |
| MAXIMUM WORKING PRESSURE | 12 Bar (175 PSI) | |
| EFFECTIVE WORKING PRESSURE | 3.5 Bar to 10.5 Bar (50 - 150 PSI) | |
| END CONNECTION | 3/4" BSPT (3/4" NPT OPTIONAL) | |
| MATERIAL | Housing & Scroll - Brass IS : 291 (EQUIVALENT TO ASTM-B21) Strainer - Copper | |
| INCLUDED WATER SPRAY ANGLE AND K-FACTOR | SPRAY ANGLE | K-FACTOR METRIC (US) |
| | 75° | - 22 (1.54) |
| | 80° | - 18 (1.26) |
| | 90° | - 32 (2.24) |
| | 100° | - 26 (1.82) |
| | 115° | - 42 (2.94) |
| | 120° | - 23 (1.61) |
| WEIGHT (Approx) | 0.200 Kg | |
| FINISH | Brass Finish Nickel Chrome Plated (optional) | |
| APPROVALS | UL Listed | |
| ORDERING INFORMATION | Specify Model, K-Factor, Spray angle and Finish | |

DESCRIPTION

High Velocity Water Spray Nozzles are internal swirl plate type open nozzles designed for use in fixed water spray or deluge system for the fire protection application.

These nozzles produce solid uniform and dense core of high velocity water spray to effect fire control. Nozzles are normally used to cool the surface as well as for extinguishment. Nozzles are typically used for Deluge protection of special hazards such as oil filled transformers, switch-gear, chemical process equipments, conveyor system and flammable liquid storage areas. The minimum desirable pressure to achieve a reasonable spray pattern is 3.5 Kg./sq.cm. (50 psi). The water distribution pattern is as shown in the graph in following pages giving maximum effective axial distance from the nozzle. The spray pattern shown is with indoor application. The system designer must consider wind velocity while designing the system for outdoor application. Field obstruction if



any affecting the spray pattern of the nozzle must be considered. The nozzle may be oriented in any position as deemed necessary to cover the hazard.

3.5 bar to 7 bar pressure at Nozzle is recommended for effective application requiring High Velocity Water delivery for rapid extinguishment of all fires by emulsification.

The Nozzles are having inbuilt Strainer, but still main pipeline strainer is required in the system.

The Blow-off cap can be used to prevent the depositing of foreign material in the water way of the nozzle. Use of Blow-off cap is optional and not UL listed.

MAINTENANCE

The spray nozzle must be handled with due care. For best results, the storage as well as any further shipment be made in original packing only.

Nozzle which is visibly damaged should not be installed. Use Teflon tape or soft thread sealant on the male thread of the nozzle.

It is recommended that the water spray system be inspected by an authorised technical personnel. The nozzle must be checked for corrosion, external and internal obstruction, blockage if any. The nozzle should be cleaned or replaced if required. The system must be operated with optimum water flow at least three times in a year or as per the provision of NFPA/TAC or local authority having jurisdiction.

The owner is solely responsible for maintaining the water spray system and components therein, so that it performs properly when required.

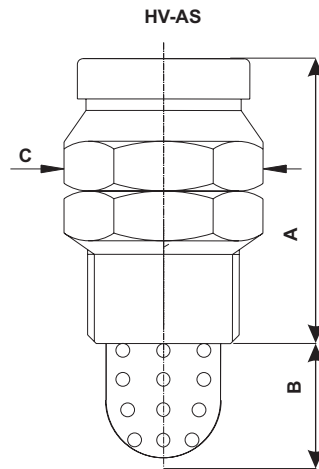

DIMENSION In millimeters (Approximate)

| NOZZLE FACTOR & SPRAY ANGLE | A | B | C A/F |
|-----------------------------|----|----|----------|
| K 22 x 75° | 49 | 21 | 30 |
| K 18 x 80° | 44 | 21 | 30 |
| K 32 x 90° | 49 | 21 | 30 |
| K 26 x 100° | 55 | 21 | 30 |
| K 23 x 120° | 49 | 21 | 30 |
| K 42 x 115° | 49 | 21 | 30 |

DISCHARGE CHARACTERISTICS

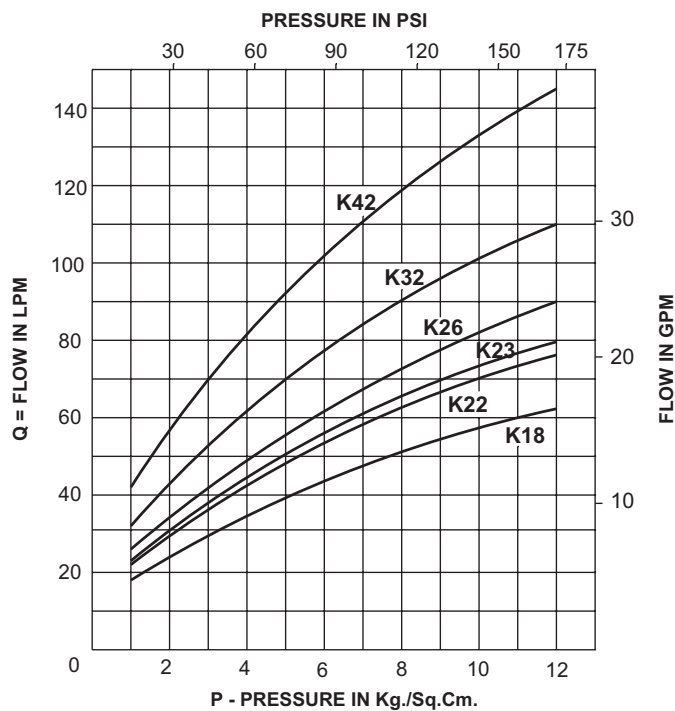

$Q = K\sqrt{P}$ where P is supply pressure in Kg/sq.cm., K= nozzle constant (K-factor) in metric
US K factor = Metric K factor \div 14.2745

SPRAY PATTERN

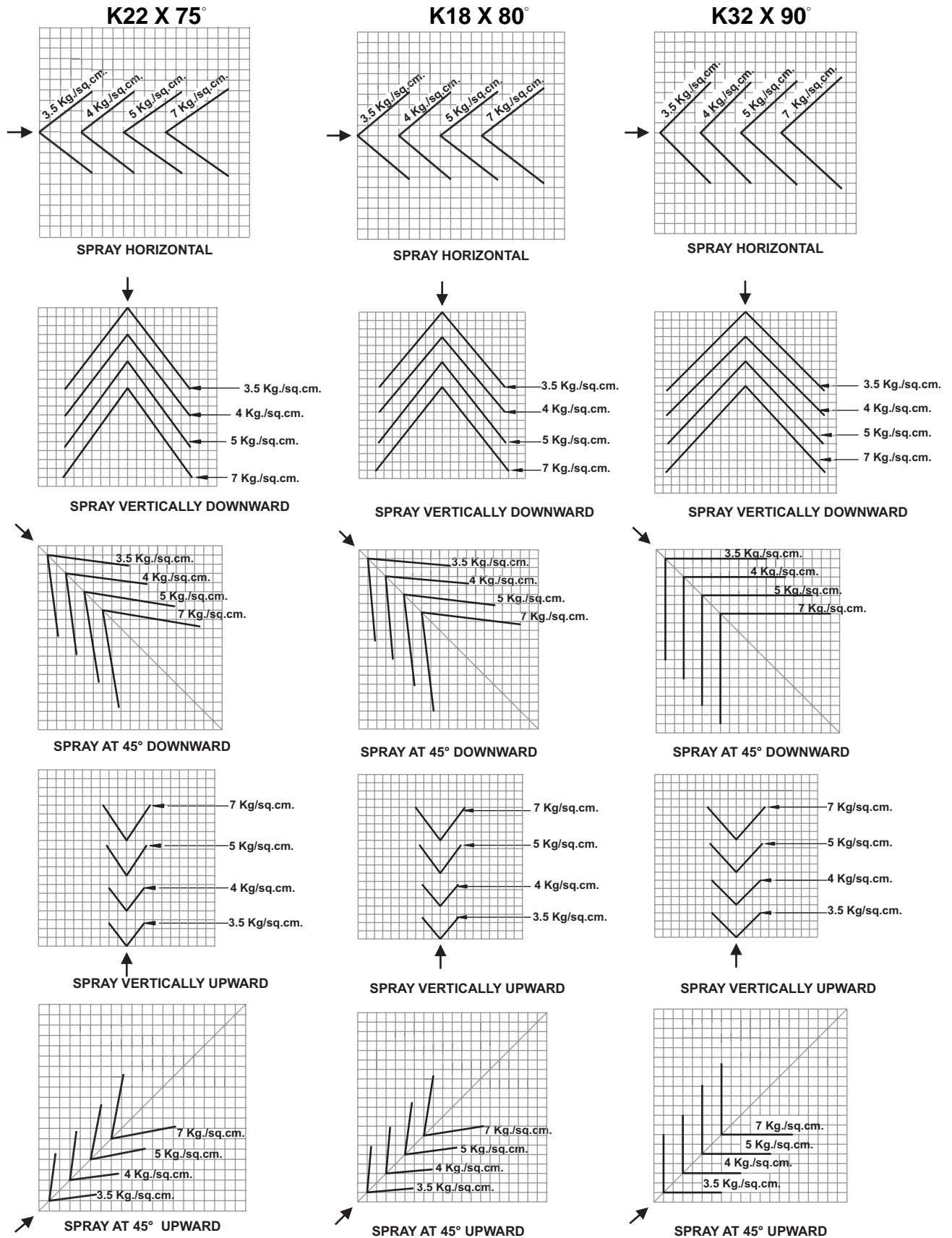

Note : One square is 200 X 200 mm.

SPRAY PATTERN

K42 X 115°

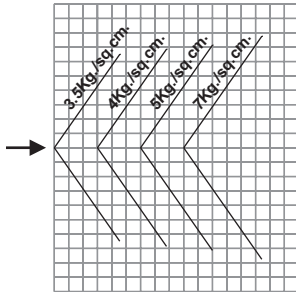

SPRAY HORIZONTAL

K23 X 120°

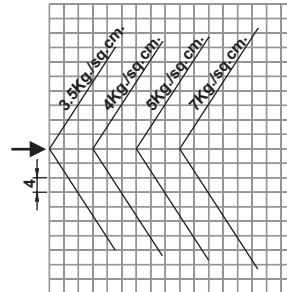

SPRAY HORIZONTAL

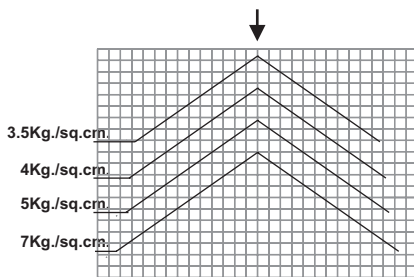

SPRAY VERTICALLY DOWNWARD

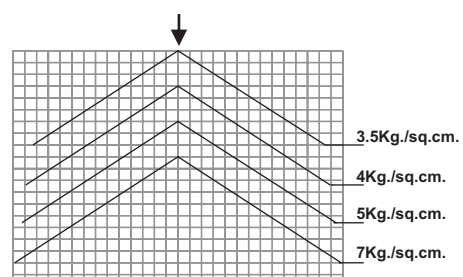

SPRAY VERTICALLY DOWNWARD

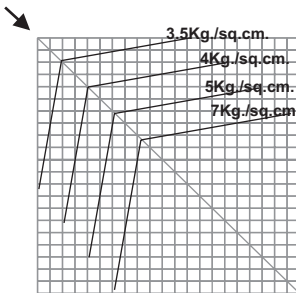

SPRAY AT 45° DOWNWARD

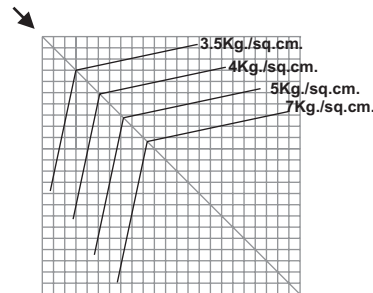

SPRAY AT 45° DOWNWARD

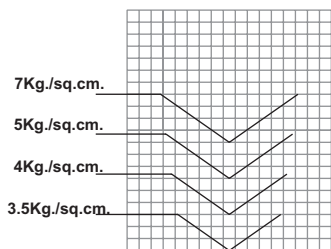

SPRAY VERTICALLY UPWARD

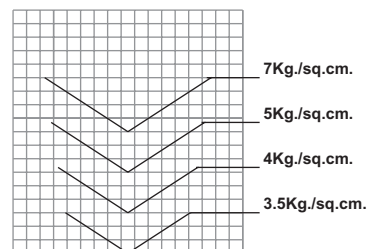

SPRAY VERTICALLY UPWARD

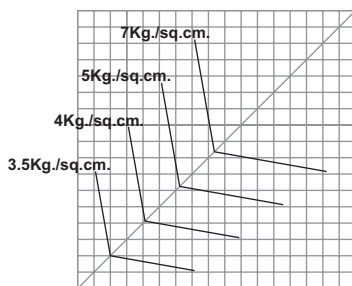

SPRAY AT 45° UPWARD

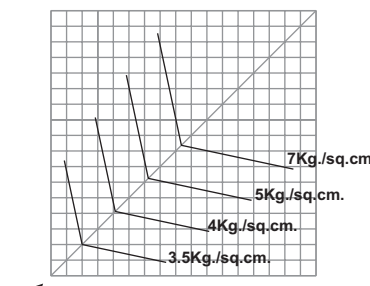

SPRAY AT 45° UPWARD

Note : One square is 200 X 200 mm.

SPRAY PATTERN

K26 X 100°

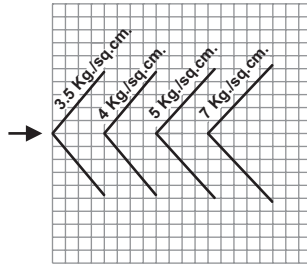

SPRAY HORIZONTAL

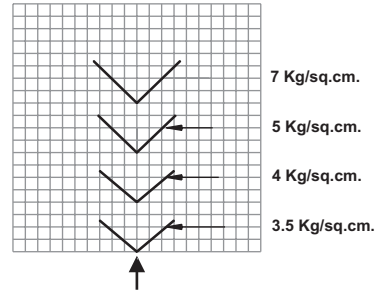

SPRAY VERTICALLY UPWARD

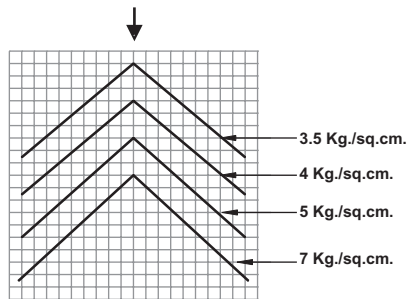

SPRAY VERTICALLY DOWNWARD

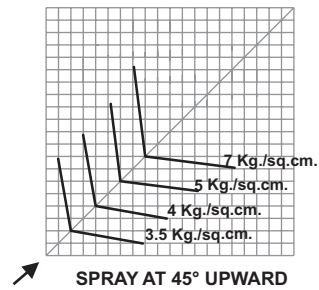

SPRAY AT 45° UPWARD

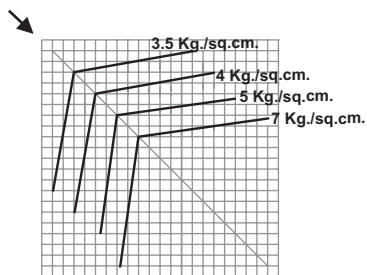

SPRAY AT 45° DOWNWARD

Note : One square is 200 X 200 mm.

LIMITED WARRANTY

HD FIRE PROTECT PVT. LTD. hereby referred to as HD FIRE warrants to the original purchaser of the fire protection products manufactured by HD FIRE and to any other person to whom such equipment is transferred, that such products will be free from defect in material and workmanship under normal use and care, for two (2) years from the date of shipment by HD FIRE. Products or Components supplied or used by HD FIRE, but manufactured by others, are warranted only to the extent of the manufacturer's warranty. No warranty is given for product or components which have been subject to misuse, improper installation, corrosion, unauthorized repair, alteration or un-maintained. HD FIRE shall not be responsible for system design errors or improper installation or inaccurate or incomplete information supplied by buyer or buyer's representatives.

HD FIRE will repair or replace defective material free of charge, which is returned to our factory, transportation charge prepaid, provided after our inspection the material is found to have been defective at the time of initial shipment from our works. HD FIRE shall not be liable for any incidental or consequential loss, damage or expense arising directly or indirectly from the use of the product including damages for injury to person, damages to property and penalties resulting from any products and components manufactured by HD FIRE. HD FIRE shall not be liable for any damages or labour charges or expense in making repair or adjustment to the product. HD FIRE shall not be liable for any damages or charges sustained in the adaptation or use of its engineering data & services. In no event shall HD Fire's product liability exceed an amount equal to the sale price.

The foregoing warranty is exclusive and in lieu of all other warranties and representation whether expressed, implied, oral or written, including but not limited to, any implied warranties or merchantability or fitness for a particular purpose. All such other warranties and representations are hereby cancelled.

NOTICE :

The equipment presented in this bulletin is to be installed in accordance with the latest publication standards of NFPA or other similar organisations and also with the provision of government codes or ordinances wherever applicable.

The information provided by us are to the best of our knowledge and belief, and are general guidelines only. Site handling and installation control is beyond our reach. Hence we give no guarantee for result and take no liability for damages, loss or penalties whatsoever, resulting from our suggestion, information, recommendation or damages due to our product.

Product development is a continuous programme of HD FIRE PROTECT PVT. LTD. and hence the right to modify any specification without prior notice is reserved with the company.

**HD FIRE PROTECT
PVT. LTD.**

C-3/6, THE NANDANVAN IND. ESTATE, L.B.S. MARG, THANE 400 604., INDIA.
• PHONES : + (91) 22 2583 5434 • 2582 6958 • 2582 6793
• FAX : +(91) 22 2581 2524 • 6796 9049
• EMAIL : info@hdfire.com • WEBSITE : www.hdfire.com