



CEASEFIRE WORLD SERIES

Kitchen Firefighting Range



Globally Certified Quality.
Now in the United Kingdom.





CEASEFIRE INDUSTRIES UK LTD

Ceasefire UK is a 100%-owned subsidiary of Ceasefire Industries, the most trusted fire safety brand in India and a fast emerging global conglomerate. With its globally certified, holistically-integrated range of fire fighting solutions, the company is amongst the rarest in the world to have such a diverse product portfolio as part of one eco-system.



The company is a leading manufacturer of a 360 degree-unified product range that includes - A Complete line of Fire Extinguishers with the widest variety of extinguishing agents, Special Application Extinguishers, Highly-advanced In-Panel Suppression Systems, Total Flooding Systems, Greenest technologies including Inert Gas Based Suppression, Revolutionary Watermist Based Suppression Systems, Extensive range of Watermist and Wet chemical Based Kitchen Fire Suppression Systems, Hydrant Systems, Fire Alarm Systems and other highly-specialised fire fighting technologies.

This extensive product portfolio is built at the very forefront of technology and conforms to the highest global standards and carry a host of international certifications by world's top-notch quality agencies including - EN3, EN1866, LPCB, BSI, MED, PED, VDS, ISO9001. Manufactured at the company's state-of-the-art production facility in India, Ceasefire's fire fighting solutions are setting global benchmarks in quality..

Best names across industry segments in India and other parts of the world have counted on us for their safety, including global giants, MNCs, Government Agencies, Railways, Airports and Military & Strategic Establishments.

Totalling 500,000 customers. We've never let anyone down, ever.



A range certified for quality by the top-notch agencies in the world.



A FULL-SPECTRUM KITCHEN SYSTEMS RANGE



Ceasefire today offers an integrated range of kitchen fire suppression systems to suit the needs of every kind of a kitchen, be it a commercial one or domestic. The range includes Watermist & Wetchemical Based Systems for both Commercial and Domestic applications.

Certified by the world's best agencies

Ceasefire's Commercial kitchen systems are fully certified by LPCB to LPS 1223 standard and the Domestic systems are tested by BSI for performance & safety.



CERTIFICATIONS

CEASEFIRE KITCHEN FIRE FIGHTING RANGE



LPS 1223
Cert/LPCB Ref. 1329a

CEASEFIRE'S COMMERCIAL KITCHEN
HOOD FIRE SUPPRESSION RANGE, INCLUDING
BOTH WATERMIST & WET CHEMICAL BASED
SYSTEMS

bsi.

CEASEFIRE DOMESTIC
KITCHEN FIRE
SUPPRESSION SYSTEM

Tested by
BSI

INDUSTRY ASSOCIATION



NEXT GENERATION TECHNOLOGY FOR KITCHENS

Advanced Heat Sensitive Tube Based Linear Detection



- 1** The most prominent feature of the Ceasefire Kitchen fire suppression systems is a specially designed heat-sensitive pneumatic polymer tube that runs unobtrusively throughout the length of hood including the plenum and the duct area.

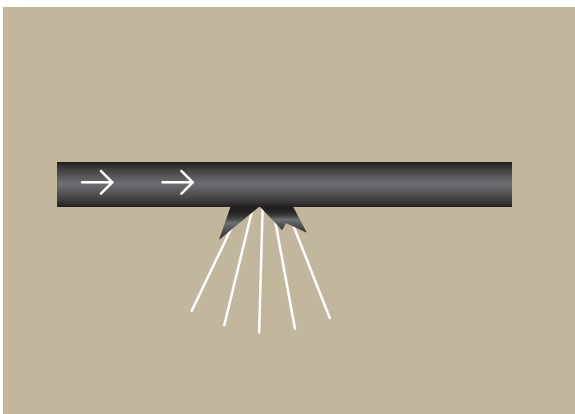

- 2** When a fire breaks out, the heat-sensitive tube detects the rise in temperature and punctures at that point.

- 3** This triggers the system, which releases the extinguishing agent through a separate discharge line and expels it into the cooking area, plenum & the duct, through specialized nozzles ensuring no blind spots during fire fighting.

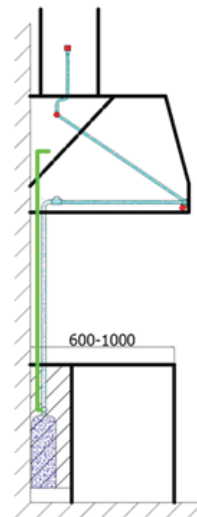

- 4** Dousing the flames by smothering them with the spray of the agent and bringing down the temperature to below combustion levels.

COMPLETE FREEDOM OF MOVEMENT TO THE CHEF

Flexibility to decide hot and cold cooking areas

The key advantage of the Heat Sensing Tube based detection is that it provides linear/uniform protection throughout the length of the kitchen hood, space behind the filters and even in the duct areas. This is a huge advantage over the spot-detection based systems using fuseable plugs/links which are sensitive to detect fire only under specific points under the kitchen hood. The feature gives complete freedom to the chef to move the hot (cooking) area and cold (preparation) area as per his wish or as the meal service of the day demands.



WHAT MAKES THESE SYSTEMS TRULY REMARKABLE!

Always Ready & Low on Maintenance

The USP of the Ceasefire kitchen suppression systems is that being Stored Pressure Type systems, these are swift & powerful and require minimal maintenance as compared to cartridge type or pump based systems.

Low Pressure; Safe Systems

The systems are low pressure type (15 bar pressure), making them absolutely safe for people in the kitchen.

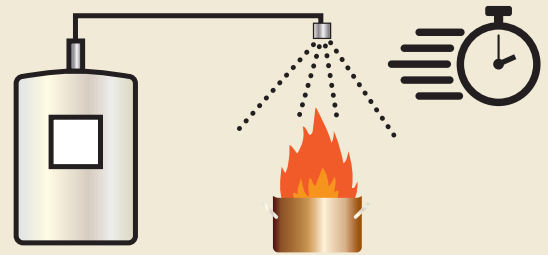
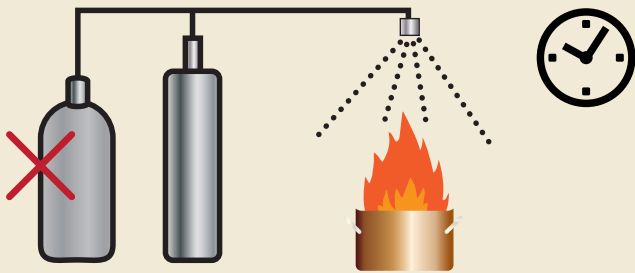

Highly Intelligent Response Panel

The systems comes fitted with a state-of-the-art Response Panel that not only gives a ready health check of the system, but makes it integrateable to other third party devices present at the premises like Fire Alarms, Gas Shut-off Valves, etc. The unique design of the Cylinder Valve makes it tamper proof and safe against accidental shutting-off of the system while cleaning or maintenance. Status of the open/close position of the valve can be readily checked in the large & clear LCD display of Response Panel.



The Ceasefire Kitchen Fire Suppression Systems provide effective protection for kitchens with all types of cooking applications like frying, stir frying, roasting, baking.

IN-HOUSE DESIGN CAPABILITY

Customized for Every Kitchen

The true advantage of Ceasefire's Kitchen Fire Suppression Systems come with the company's In-house Design Capability. The Design cell comprises of a team of qualified Engineers, CAD Designers and Fire Experts who have extensive experience of customizing fire suppression systems for a wide variety of commercial & domestic kitchens.

Every system is customized for the kitchen it is installed in, considering the length of the kitchen hood along with every other aspect of fire threat & assessment of collateral damages at the premises. The design of every system follows predefined guidelines and principles laid out by LPCB, the quality certification agency for Ceasefire Kitchen Systems.



SPECIALIZED FIRE EXTINGUISHERS TO COMPLEMENT THE RANGE

In addition to the range of Kitchen Fire Suppression Systems, Ceasefire offers specialized fire extinguishers for kitchen applications. These include Watermist, Foammist and Wet Chemical extinguishers of sizes 2, 3, 6 & 9 ltrs 2 & 6 ltrs and 3, 6 & 9 ltrs respectively.

These agents have a proven track record against the specially challenging kitchen / super heated cooking oil fires. While Watermist kills the kitchen fires by rapid evaporation in the fire zone and blocking oxygen and bringing down the temperature, Foammist & Wet Chemical do the job by a powerful blanketing effect on the fire and bringing down the temperature to below combustion levels.



THE MOST HOLISTICALLY INTEGRATED FIRE FIGHTING RANGE.

The Ceasefire ecosystem has evolved to encompass a very dynamic and diverse range of fire safety products that truly complement each other. The result is a 360 degree,

holistically-integrated range that can address any kind of fire safety requirement for any kind of premises with utmost perfection.



Wide range of Portable & Trolley Mounted Fire Extinguishers

ABC Powder, Water & CO₂-based extinguishers. Certified to EN3 / EN1866 standards.



Portable & Trolley Mounted Watermist-based Extinguishers

Exclusive range of Watermist-based portable and trolley mounted fire extinguishers, ready to fight large fires without any collateral damage.



Special Application Fire Extinguishers

Feature-full Clean Agent, Wet Chemical and Special Agent for Class B and Metal Fire-based fire extinguishers.



Designer Series Home & Car Fire Extinguishers

ABC Powder & Clean Agent-based fire extinguishers that come in aesthetically pleasing designs and colours.



In-Panel Tube-based Fire Suppression System

Certified by LPCB for LPS1666 Standard Certification for 2 and 4 kg HFC227ea and HFC236Fa gas variants.



Kitchen Hood Fire Suppression Systems

Watermist and Wet Chemical-based Systems. Certified by LPCB for LPS1223 Standard Certification. The range also includes BSI tested systems for domestic kitchen application.



Watermist-based Suppression Systems

Watermist-based Systems with LPCB certified nozzles for exclusive application in Offices, Warehouses, Factories, Generator and Transformer areas.



Specialised Gas-based Suppression Systems

HFC227ea-based System, available in both Engineered and Pre-engineered variants. Certified by LPCB for LPS1230 Standard Certification.



Inert Gas & CO₂ Based Suppression Systems

Ceasefire's VDS approved Inert Gas and CO₂ based systems are the greenest and most powerful extinguishing systems available today in the world.



Retrofittable Suppression Systems

Ceasefire Atom X, retrofittable suppression system that requires minimal pipes and fittings and consumes least amount of your productive work space.



Hydrant Systems

Completely Independent Watermist-based Hydrant Systems.



Fire Alarm Systems

Ceasefire's CF XPlus range of Fire Alarm systems come in a complete spectrum of Conventional, Addressable, Wireless and Standalone systems.



Special Firefighting Systems

Advanced firefighting systems that are the first of their kind in the world.

Technological leader. Demand generator.



Through our extensive fire safety product portfolio, unmatched quality and knowhow, and by bringing high end products to

existing, new and lower market denominators, we've been known to open market opportunities exponentially for Ceasefire's Business Associates.

PARTNER WITH CEASEFIRE.

Ceasefire hand-holds its business associates to grow along with the organization. There are a number of facilities & services designed to give our partners a platform to gather knowledge and use the Ceasefire market experience to their advantage.

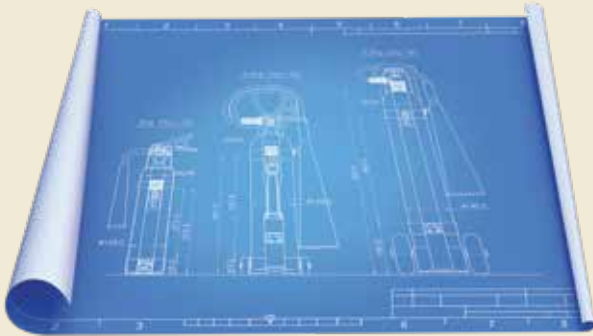

Extensive Technical Support: A key support to the Ceasefire Business Associates is the carefully crafted Technical Support module from the company.

This module allows a Ceasefire Business Associate to request support through:



Email



Call



Live Call Support



Accompanied Calls

Ceasefire embeds extensive training and development into its system to build a unique competitive edge.



Ceasefire Academy of Forging Excellence (CAFE):

Most advanced training platform with a blended learning approach deploying effectively online training, instructor-lead sessions, tests and periodic evaluation.



Live Webinars:

These Webinars are an effective tool at the disposal of the Business partner to market the Ceasefire technologies to their customers, in addition to using these as a self-learning and doubt clearing sessions.

Ceasefire E Proposal Utility: Our Business associates get access to their exclusive login page on the Ceasefire Customer Relations Portal (CCRM), which acts as the single dashboard window to access every resource available for them in the company. The module allow the users to create most appealing and customized proposal documents at the click of a button. The portal is a repository of standard proposal templates as well as elaborate Digital Library that hosts a variety of documents like Data Sheets, Certificates, Videos, Product Brochures and lot more.



The Ceasefire partner support does not end at providing technical and product support. We go an extra mile to give marketing and logistic support to our partners to ensure its a winning game for them.



Marketing Collaterals + Emailer Module:

The CCRM login page gives business associates access to a whole host of marketing collaterals like brochures, print ads, social media/digital ads, BTL collaterals and more.

Apart from the support on marketing collaterals, the system also enables the business partner to automate email marketing, SMS and Whatsapp marketing for themselves.



Order Tracking & Logistics:

The CCRM Login also provides a very smart dashboard view to Ceasefire Business Associates to be able to track all-important events, activities & their progress. This includes the status of their orders, payments, dispatch, transit, billing and much more.

CONTENTS

KITCHEN FIREFIGHTING RANGE

COMMERCIAL SYSTEMS

Watermist Based Kitchen
Suppression System **18**

Wet Chemical Based Kitchen
Suppression System **40**

Technical Specifications **50**

Technical Diagrams **58**

DOMESTIC SYSTEMS

Watermist Based Domestic
Kitchen Suppression System **69**

Wet Chemical Based Domestic
Kitchen Suppression System **74**

PORTABLE EXTINGUISHERS

Watermist & Foammist Based
Portable Extinguishers **80**

Wet Chemical Based
Portable Extinguishers **82**

WHY CEASEFIRE **84**



The logo consists of the words "CEASE" and "FIRE" stacked vertically in a bold, sans-serif font, enclosed within a square border.The text "WORLD SERIES" is displayed in a bold, sans-serif font. Behind the text is a faint, dotted map of the world.

CEASEFIRE'S KITCHEN FIREFIGHTING RANGE

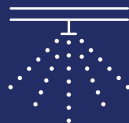

INTRODUCING THE CEASEFIRE KITCHEN FIREFIGHTING RANGE



There is no denying the fact that fire is central to cooking. Every day, restaurants, cafés, bakeries and commercial kitchens use it to create a myriad number of delicacies. However, the liberal use of fire, and the presence of combustible substances like oil, make it almost easy for an accident to flare up.

In large hotel chains with hectic, time bound meal services keeping the staff rushing around, these accidents are just waiting to happen. Such an accident can shut down your operations for several days, causing a substantial loss of business revenue. Not to mention the irreversible damage to the reputation of the brand you've carefully built over the years...gone in minutes.

While fires on their own are dangerous, kitchen fires take things to a whole new level.

Kitchen fires are some of the toughest, fiercest fires to fight and control. Cooking areas and kitchen hoods are particularly prone to accidents.

Once oil reaches a certain temperature, it releases fumes that burn at a lower temperature than oil. In seconds, this can turn into a fire situation threatening to get out of control, reaching temperatures as high as 350°C, endangering precious lives and destroying expensive kitchen equipment. What's more, with other inflammables like LPG on the premises, the danger is considerably aggravated.

Until recently, the only way to put out an oil fire in the kitchen was by using conventional extinguishers, which destroyed all the ingredients in the kitchen, not to mention being harmful to the environment as well.

There was an urgent need for specialised extinguishers and systems to come to the rescue. That's where Ceasefire comes in. Developed using cutting-edge technology, the Ceasefire Kitchen Firefighting Range offers 360° protection for your establishment's kitchen. These lifesaving equipment are so advanced they've been certified globally to be among the best in the world. Which is why, whether it's a small café or a large industrial kitchen, Ceasefire is equipped and ready to protect.



Watermist Kitchen Firefighting Range

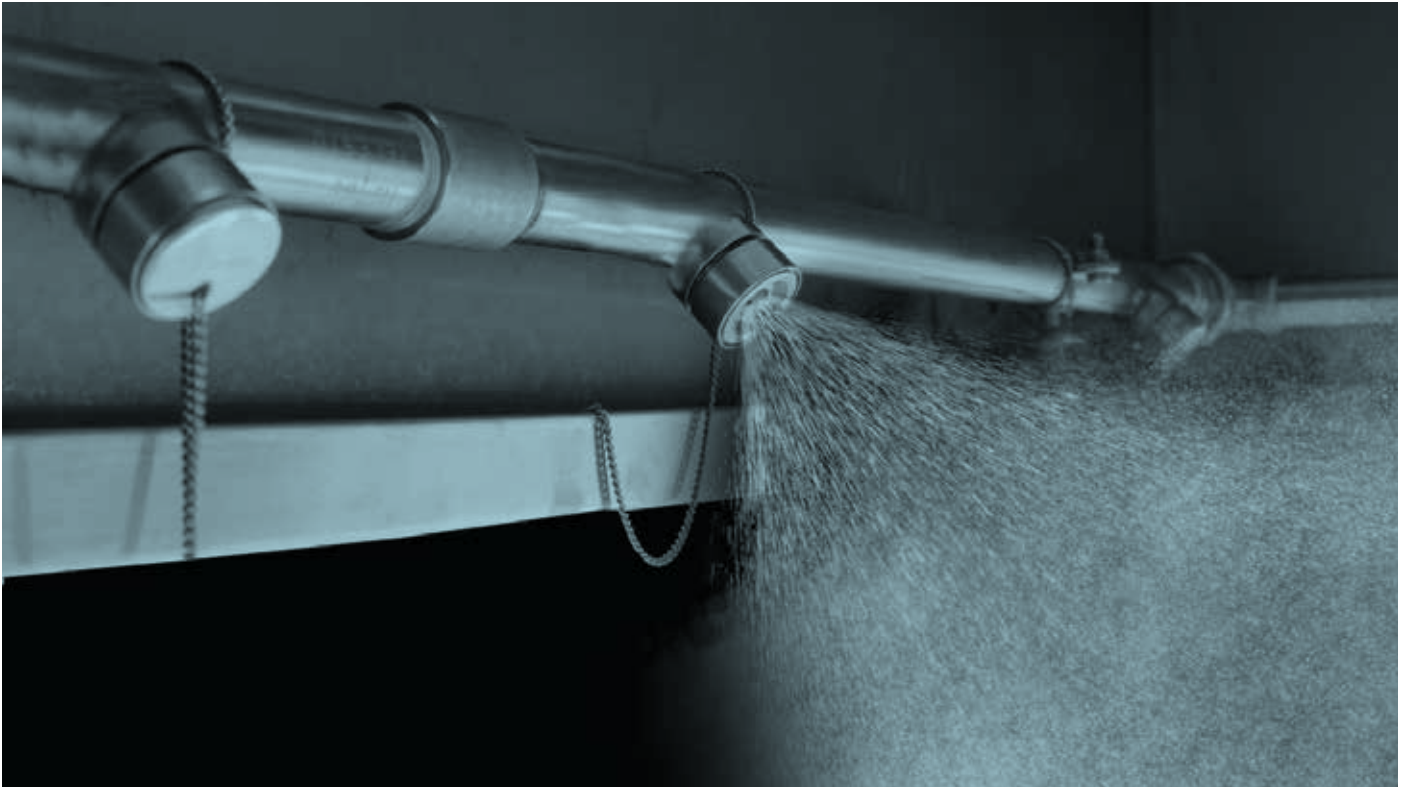

The Watermist Based Kitchen Fire Fighting Range:

Ceasefire's range of watermist based kitchen fire fighting solutions has an automatic kitchen fire suppression system and a range of portable extinguishers to guard all kinds of kitchen centric premises.



Range Of Kitchen Suppression Systems (Watermist):

Watermist systems are designed to protect different hood sizes against fire - with no collateral damage.



The Ceasefire Watermist and foammist based Portable Extinguisher:

A standalone watermist and foammist fire extinguishers can take on and bring down an oil fire with ease.

Wet Chemical Kitchen Firefighting Range



The Wet Chemical Based Kitchen Fire Fighting Range :

Powered by a Wet Chemical, Ceasefire's range of automatic kitchen fire suppression system and a range of portable extinguishers are ideal first line of defense for any kind of commercial kitchens.



Range Of Kitchen Suppression Systems (Wet Chemical):

Ceasefire's Wet Chemical-based fire suppression systems are specially designed for kitchen hoods and built to fight oil fires without any flooding-related collateral damage.



The Ceasefire Wet Chemical Portable Extinguisher:

Ceasefire's Wet Chemical-based fire extinguishers are ideal to combat cooking oil based fires that arise in commercial kitchens.

The logo consists of the words "CEASE" and "FIRE" stacked vertically in a bold, sans-serif font, enclosed within a square border.The text "WORLD SERIES" is displayed in a bold, sans-serif font. Behind the text is a faint, dotted map of the world.

WATERMIST BASED KITCHEN SUPPRESSION SYSTEM

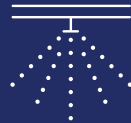

HARNESSING THE POWER OF WATER, AND MULTIPLYING IT.

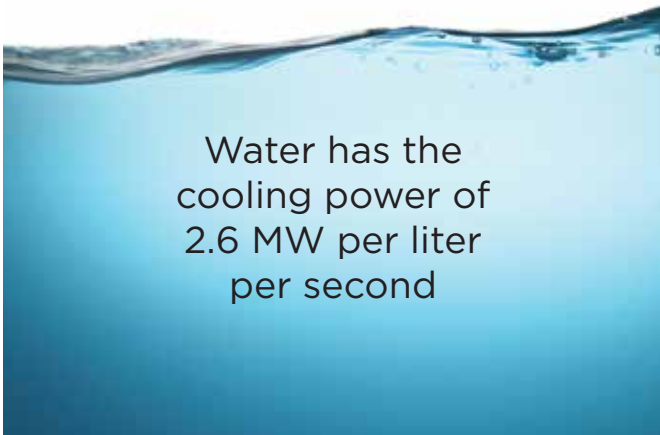

It's common knowledge that there is no extinguishing agent more potent than water. With its massive cooling power of 2.6 MW per liter per second, water kills even the largest of fires in minutes. But even fire's worst adversary has its shortcomings. Using water on oil fires or an electrically started blaze can be a fatal mistake. What you need is cutting-edge technology that changes water's natural physical form, so that it can fight kitchen fires without causing any collateral damage.

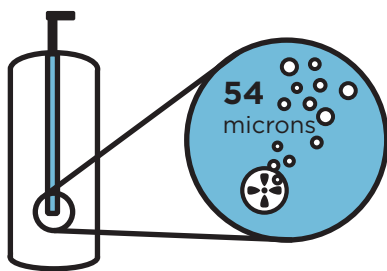

First, the Multi-Rotors and Nozzles located within the **system turn water into droplets of 54 micron size** by mixing it with air in a pre-set proportion.



This makes it the only system of its kind that combines two revolutionary technologies - Watermist and stored pressure - into an extinguisher that **can take down even the largest of fires, including oil and electrically started fires.**

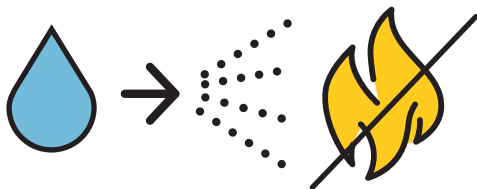

This produces Watermist, which **increases the coverage area of water to fight fires many times over.** The stored pressure technology is used to deliver Watermist with a kinetic force strong enough to overcome the fire's own convection currents.

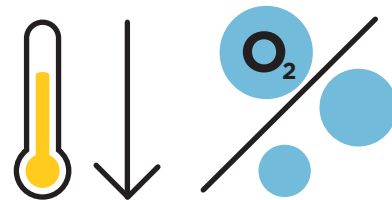

When Watermist falls on the fire, it **rapidly brings down the temperature to below combustible levels, cuts off the oxygen supply and kills the flames.**

ENVIRO SERIES / ENGINEERED

WATERMIST BASED KITCHEN SUPPRESSION SYSTEM

**CERTIFIED BY LPCB FOR
LPS 1223 STANDARD**



The Watermist Based Kitchen Suppression System comes with an advanced detection mechanism. Its Pneumatic Heat Sensing Tubes run through the length of the hood, covering all vulnerable areas giving continuous protection.

In an event of a fire, these tubes (pressurised with N_2) burst at a pre-set temperature - creating a puncture in the tube - allowing the pressurised nitrogen to escape and the pressure to drop. This fall of pressure activates the valves, allowing the rotors placed inside them to mix air and water in pre-set proportions.

When these particles of air and water reach the nozzles, their combined velocity atomises the water particles to create micro-mini droplets of 54 microns. And it is this Watermist that's propelled through the nozzles onto the fire. Quickly turning into steam, blocking the oxygen supply, and bringing the temperature to below combustion levels.



The huge benefit of Watermist is that it is an absolutely clean extinguishing agent. Which means it doesn't cause any damage; either to the expensive kitchen equipment or food items. Allowing the kitchen to get back into action without any significant downtime.

Another big advantage of the system is the Heat Sensing Tubes, that provide uniform, multi point detection throughout the length of the hood; unlike the fusible plug/link based detection which is built to detect fires right below the point where

they are placed. This enables the chef to move the hot area as per the requirement of the meal service, without any hassle.

The nozzles too are versatile, and are designed to extinguish fires arisen due to deep frying, shallow frying, baking, grilling or roasting.

CEASEFIRE'S WATERMIST BASED KITCHEN SUPPRESSION SYSTEM

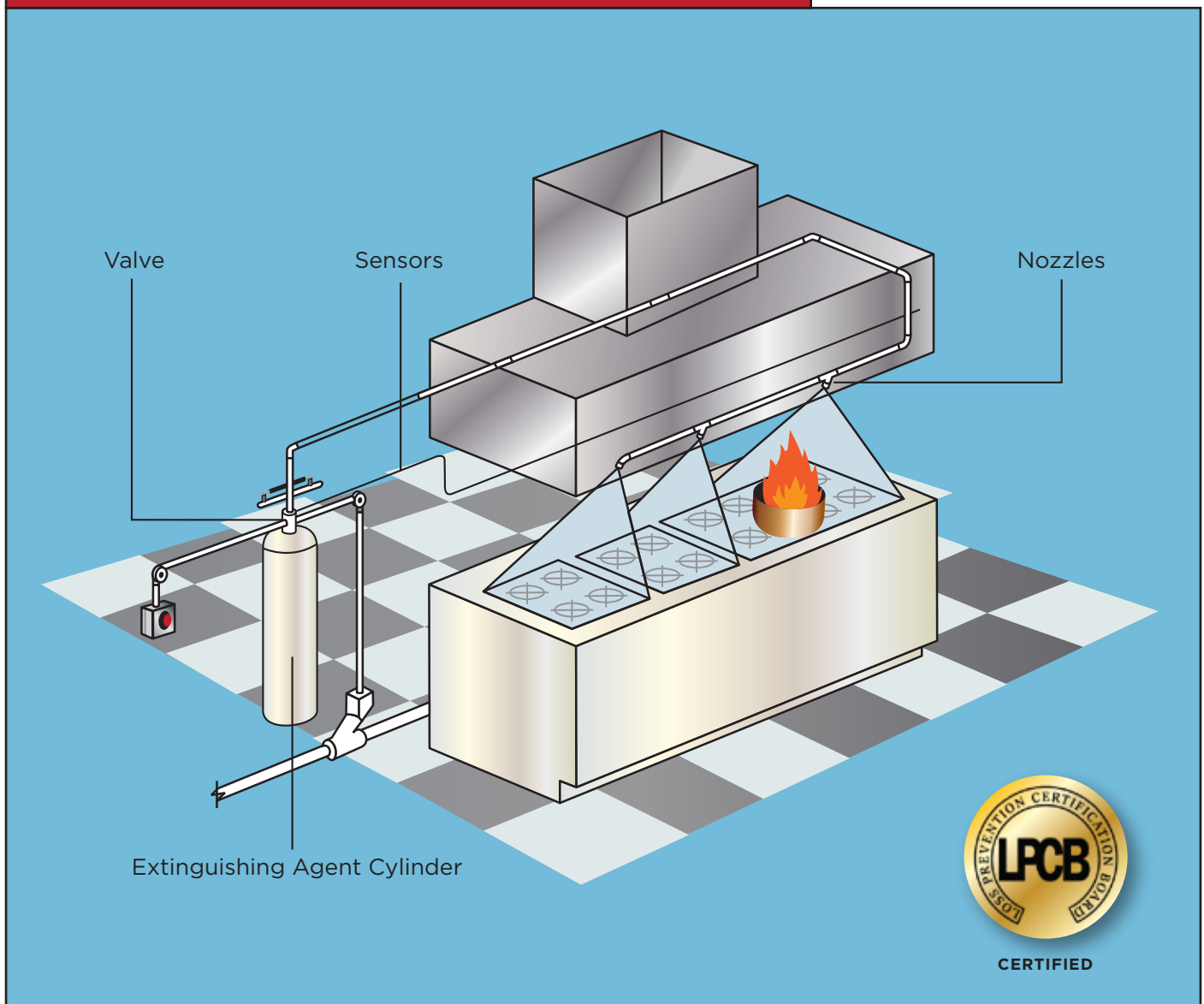

Key Components of the System

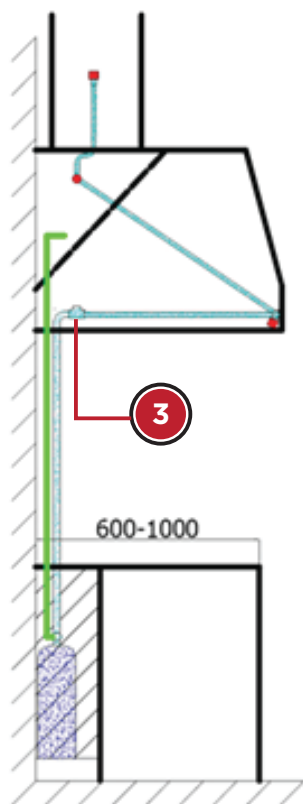

View from the side of the wall mounted hood.

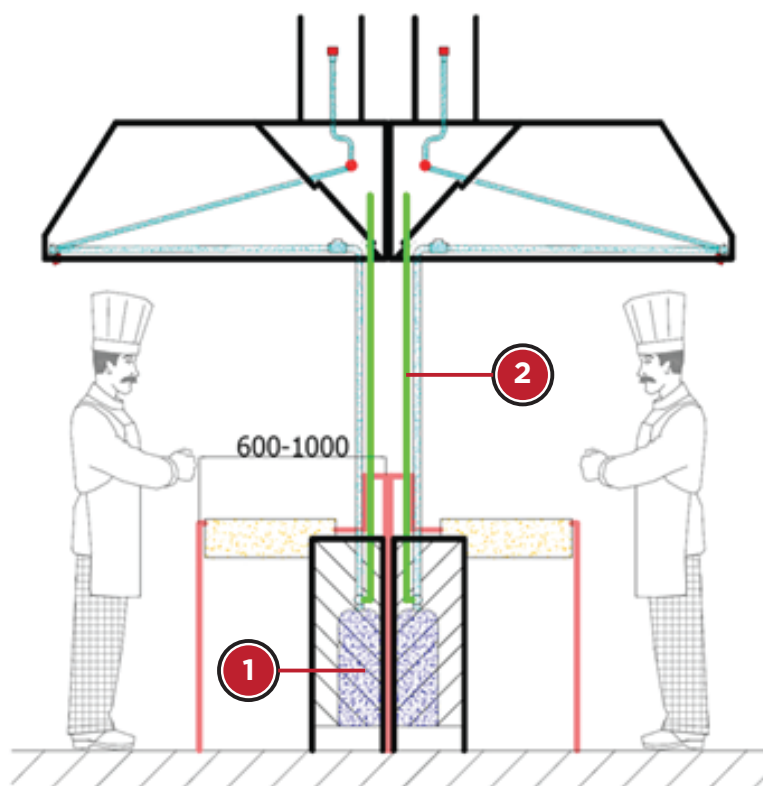

View from the side of "hanged" hoods.

1

Supply Unit

The supply unit is based on rotors placed in cylinders filled with demineralised water (50-72% volume of cylinder) and gas compressed to 15+1 bars. The quantity of used rotors, cylinders and their volume depends on the size of the protected kitchen. Rotor assembly is designed to produce a pulsating flow of water, by supplying the fire extinguishing system with the proper proportions of gas and water.

2

Piping

The fittings are made of 304 grade stainless steel. The piping length and diameter depend on the size of the fire extinguishing system.

3

Multi-nozzle and Single Nozzle Heads

These H-type heads are provided with CSFH nozzles. Similar CSFH heads are also used separately in the area behind filters or in the ventilating hood. Protection caps are used to protect the installed heads against contamination of the nozzle hose during normal operation of the kitchen. The systems use several types of heads, depending on the size of the kitchen being protected.

4







Detection and Actuation Unit



The detection system gives the signal to the actuation unit, which automatically starts up the fire extinguishing system. The system has manual actuation too.

CEASEFIRE'S WATERMIST BASED KITCHEN SUPPRESSION SYSTEM GIVES YOU MORE:

- LPCB Certified System
- No collateral damage and zero downtime due to contamination thanks to Watermist
- An eco-friendly alternative to conventional extinguishing systems
- Works on class A, B, F (oil) fires and fires involving electrically charged devices
- Specially designed nozzles that use minimum water and give maximum extinguishing power
- Its heat-sensitive tube offers superior uniform protection as compared to conventional Point Detector-based Systems
- Available in 11.5 liters, 27 liters and 56 liters

Features of the Watermist Based Kitchen Suppression System

	24-hour Protection - Automatic detection and actuation controls ensure fire protection is always 'up'.
	Multiple Triggers - The system can be triggered either by the manual actuation system or the automatic detection system.
	Highly Effective - Watermist prevents re-ignition by cooling down the temperature of the heated oil.
	Minimal Downtime - The clean water leaves no toxic chemicals, doesn't damage eatables and reduces post-fire damage, ensuring the kitchen is back in service quickly.
	Unobtrusive Design - Flexible piping configurations allow for a streamlined design and convenient installation that won't interfere with kitchen workflow.
	Highly Reliable - A fully assembled and 100% tested Mechanical Control Head ensures reliable operation. Pressure gauges on the steel cylinders mark the gas levels, allowing maintenance staff to replenish it whenever required. Protective chrome nozzle covers keep the nozzles free of contamination and blockages caused by grease or other cooking by-products.

	Highly Flexible - Available in a variety of sizes that can be customised as per the application.
	LPCB Certified System
	3 Variants - Available in three variants - 11.5 ltr, 27 ltr & 56 ltr.



Watermist Based Kitchen Suppression System Components

1. SINGLE CYLINDER SUPPLY UNIT

The supply unit is based on rotors placed in cylinders filled with demineralised water (50-72% volume of cylinder) and gas compressed to 15+1 bars. The quantity of used rotors, cylinders and their volume depends on the size of the protected kitchen. Rotor assembly is designed to produce a pulsating flow of water by supplying the fire extinguishing system with the proper proportions of gas and water.

Various types of supply units can be used for kitchen extinguishing systems. They can differ with the number of cylinders, actuation mechanism and detection signal type.

Cylinders with rotors inside are filled with water up to 72% of the cylinder capacity and nitrogen/air is under the 15 bar pressure based on the following calculation:

3 liters of water per main nozzle are used in the system and 2 liters per nozzle behind the filter and in the duct. The cylinder(s) must be filled with water up to maximum 72% of the total cylinder volume. The remaining volume must be filled with gas pressurised to 15+1 bar.

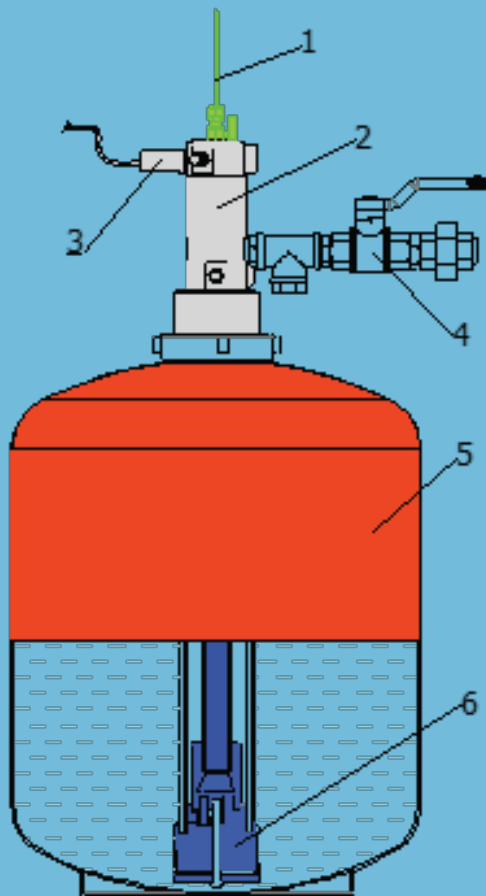

An example of the supply unit wherein one cylinder is placed with a multi-rotor set containing four rotors.

1. Detection tube
2. Indirect differential valve
3. Pressure switch
4. Servicing valve
5. Cylinder
6. Multi-rotor unit

2. INDIRECT DIFFERENTIAL VALVE

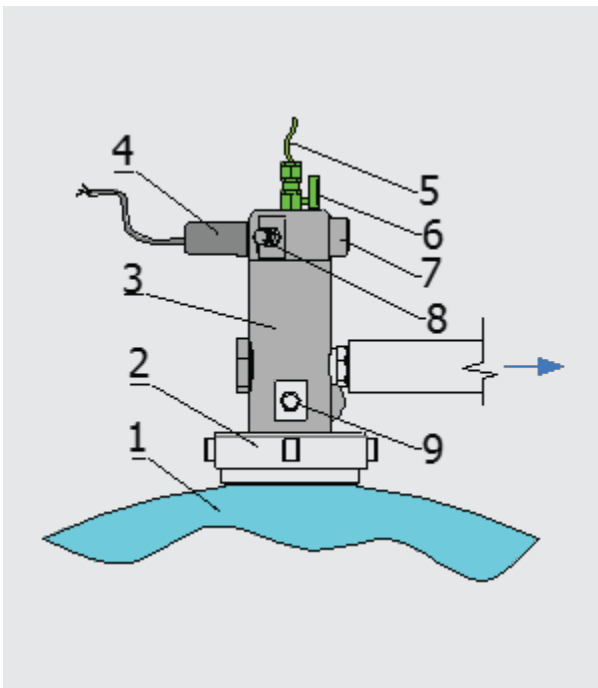

A pneumatic differential valve is used for pressure detection – fusible plug or pneumatic tube detections. A pressure drop in the system opens the valve.

An indirect valve actuation unit is used with single cylinder supply units with pressure detection.

1. Supply cylinder
2. Cylinder nut
3. Indirect differential valve
4. Pressure switch
5. Detection tube
6. Detection servicing valve
7. Pressure gauge
8. Gas filling valve (to min. 4 bar)
9. Gas filling valve (to 15 bar)

3. MULTI-ROTOR SET

The rotors installed in cylinders produce a mixture of water and nitrogen/air, which flow in a pulse manner. After system actuation, the medium flows out of the cylinders through the manifold into the main system pipe and further, via the pipeline, into the nozzles located under the hood.

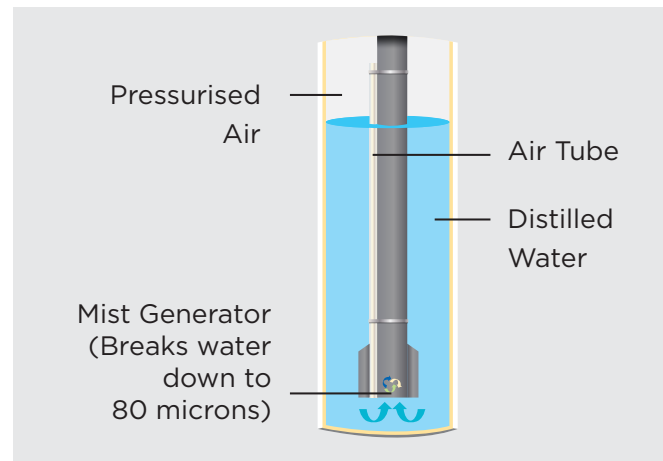

4. PRESSURE SWITCH



Every supply unit is equipped with a pressure switch, which gives a signal when the system is actuated. The signal can be used to cut off the power supply to the protected kitchen.

Optionally, one more pressure switch can be used to relate information of a pressure drop in the system via a local alarm system.

5. CEASEFIRE HEAT SENSING TUBE



In the Watermist based Kitchen Suppression System, the standard fire detection device is the Ceasefire heat sensing tube. Ceasefire's heat sensing tubes are made of high-tech plastic and are developed especially for the installation and application in automatic fire extinguishing systems.

The prescribed operating pressure is applied to the heat sensing tube after the proper installation. Due to the thermal material properties and the inner over-pressure, the heat sensing tube will burst when touched by a flame or subjected to an excessive heat increase, therefore functioning as a reliable detector in the case of a fire.

6. MANUAL ACTUATOR

Manual triggers are installed in or at the end of the detection line and simulate the heat sensing tube to burst when actuated. The drop of pressure thus generated triggers the valve.

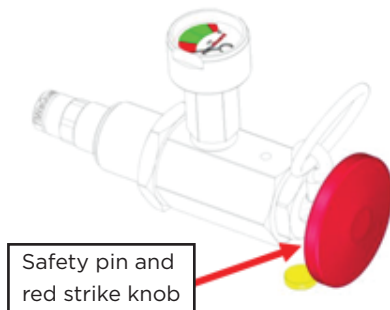

Safety pin and red strike knob

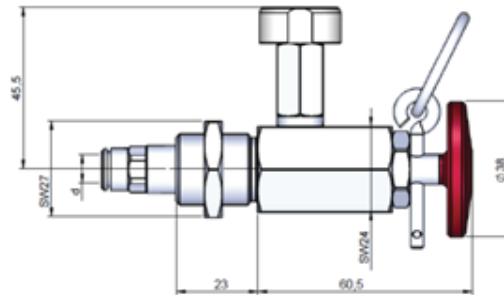

The installation of a manual trigger is mandatory. To actuate the manual trigger, pull the safety pin and press the red strike knob.

7. CEASEFIRE MULTI-BLOCK

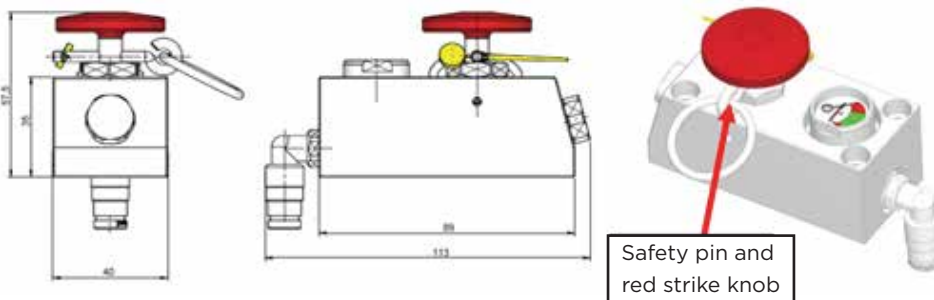

Safety pin and red strike knob

8. ELECTROMAGNETIC TRIGGER

The electromagnetic trigger provides the possibility of actuating the system by an electrical signal - a manual-electric triggering - by means of electronic buttons or switches located at various places and as far away from the extinguishing system as possible.

Using an electromagnetic trigger also minimises the risk of the operator coming into contact with the fire when manually triggering the system (depending on the position of the trigger).

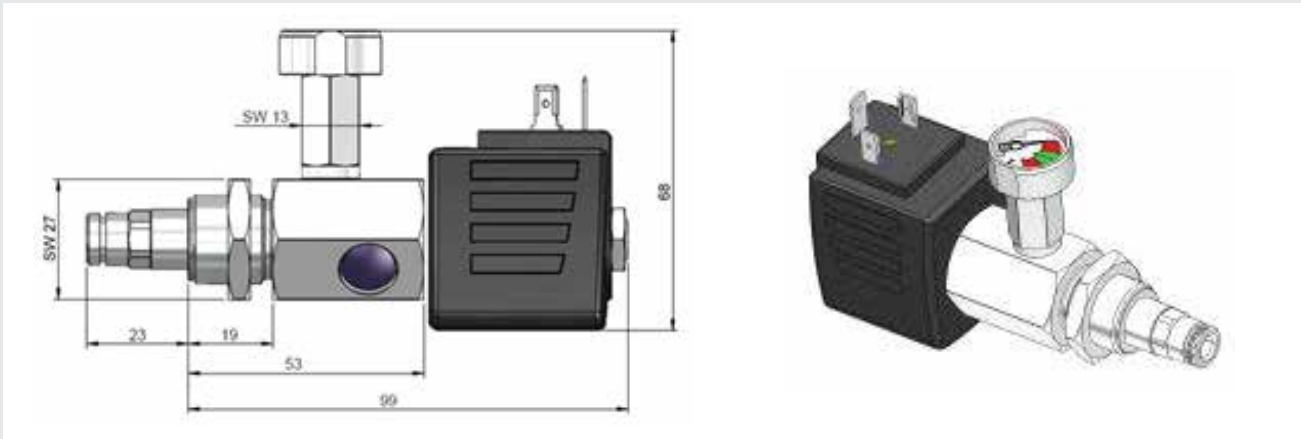

9. PIPING

The piping is a set of pipes and different hydraulic elements necessary for connecting the hydraulic elements with the fire extinguishing heads. The system piping is made of stainless steel pipes. Threaded junctions with typical plumber thread are preferable.

Hood piping is fixed by 3/8" holders and head support.

10. OPTIONAL CONTROL PANEL

The Control Panel not only helps monitor the readiness of your kitchen suppression system, which ensures you're not left high and dry in an emergency situation, but also raises the alarm.



- Activates alarm
- Compatible with third party systems
- Helps check the readiness of your kitchen suppression system

11. CONTACT GAUGE WITH SWITCHING CONTACT

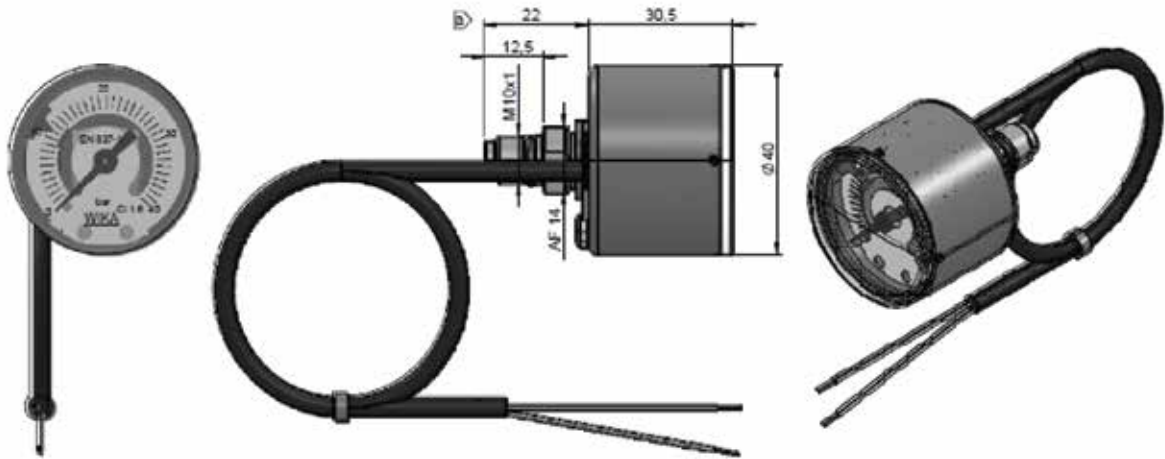

This is used to switch off the equipment when the extinguishing system is actuated. The signals can be used to cut the energy supply and, for example, switch off the extractor fan. The heat source can be stopped, as well as the extraction, but this is, however, not compulsory.

A ventilation system left running can move any smoke or exhaust gases to the outside. The decision for this option lies with the system designer, who implements it according to the customer's requirements.

Pressure range	:	0 - 40 Bars
Set points	:	11 Bars or 17 Bars
Switching mode	:	Without pressure -->Contact close (NC)
Pressure above switch point -->	:	Contact open
Switching tolerance	:	±2.5% Full scale value

Pressure gauge with limit signal transmitter type:

PGS 21.050 with double contacts applications:

- Pressure monitor for use in high pressure gas fire extinguishing systems.
- To display and monitor the container pressure and report container contents losses.
- General industry application - **Accuracy class 1.6**

Nominal size	:	50 mm
Ingress protection	:	IP65 according to EN60529 / IEC 529
Case	:	Stainless steel
Measuring element	:	Copper alloy
Motion work	:	Copper alloy
Dial	:	Aluminium white
Pointer	:	Black plastic
Viewing glass	:	Polycarbonate
Helium leakage test	:	Leakage rate 10 ⁻⁵ mbar l / sec
Electrical data	:	Switching voltage: 4.5 V ... 24VDC/VAC (±30%)
Switching current	:	5 ... 100mA
Contact load	:	Max. 2.4 W potential-free
Compressive strength	:	Steady load: 3 / 4 x full scale value
Operating temperature	:	Ambient: -20 ... +60°C

12. END OF LINE ADAPTOR

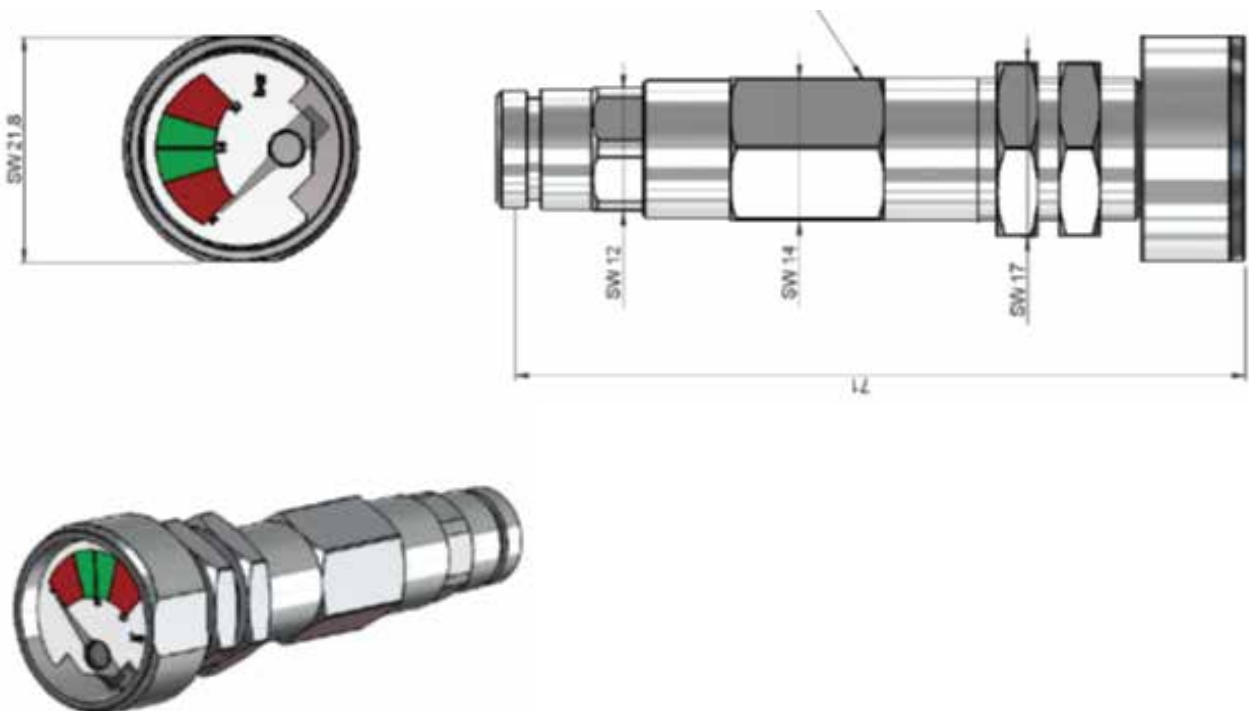

13. NOZZLES

The main fire extinguishing line is installed along the front edge of the hood. It consists of CSFH type or type H multi-nozzles, which are basically manifold CSFH nozzles.

The manifold pipe can be of diameter DN 15 (½”).



1. For hoods with 0.4 - 0.8 m distance from the worktop, CSFH 16 nozzles are used.
2. For hoods with 0.8 - 1.5 m distance from the worktop, CSFH 08 nozzles are used.

NCSFH 08 Nozzle Data Sheet

Full description: NCSFH 08.X.Y

NCSFH - Net Filter Circle Single Fluid Head

08 - Model number

X - Kind of material:

- 1** stainless steel (316)
- 2** stainless steel (304)
- 3** brass (C37800)
- 4** brass (CuZn36Pb2As)

Y - 0 without cap

- 1** silicone protection cap
- 2** stainless steel

System Type:

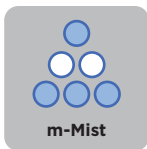
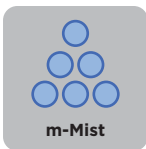

Application:

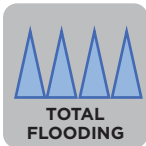

NCSFH 08.1.0



NCSFH 08.1.1

NCSFH 08.1.2

TECHNICAL PARAMETERS

Basic extinguishing media	: Water
Net filter opening	: 0.4 x 0.4 mm
Droplet size Dv	: 505 - 110 μm
Connection size	: " BSP ext.
Inlet pressure	: 6 - 16 bar
K factor	: 3.0
Number of orifice pairs	: 4
Head weight	: 0.2 kg
Protection cap	: Silicon cap Cat. No. - N 116 SS cap Cat. No. - K 059

TECHNICAL DETAILS

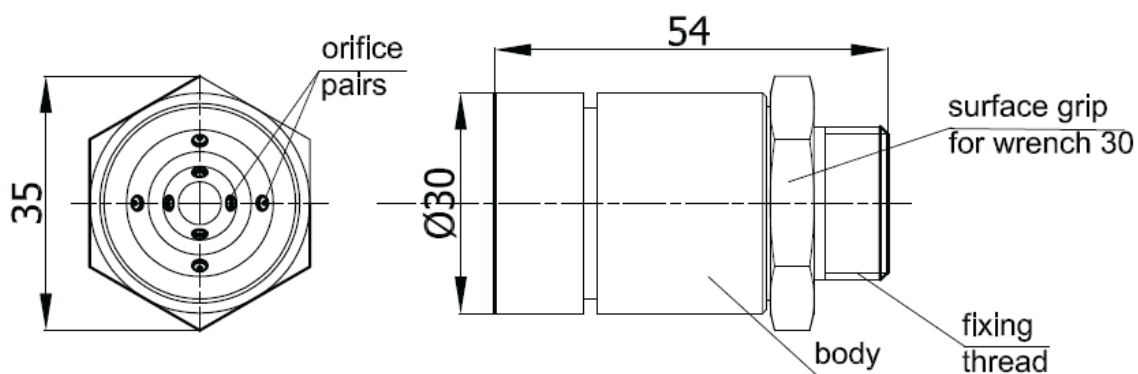

MIST STREAM

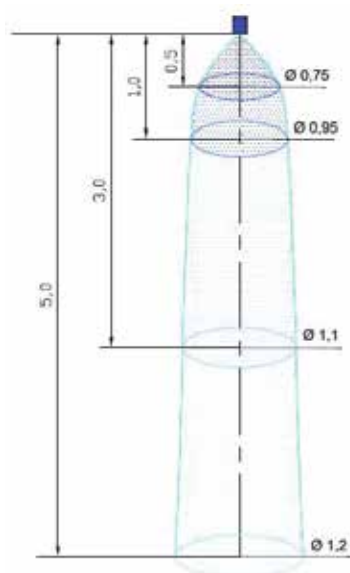

MIST STREAM PARAMETERS

Working pressure [bar]	:	6	8	12	16
K flow factor	:	3.0			
Extinguishing agent expenditure [lit/min]	:	7.5	8.5	10.5	12.0
Effective stream range * [m]	:	1.6	1.8	2.1	2.4

*Range of horizontal stream.

Our products are being constantly developed and improved, therefore we reserve the right to change technical specifications without prior notice.

NCSFH 10 Nozzle Data Sheet

Full description: NCSFH 10.X.Y

NCSFH - Net Filter Circle Single Fluid Head

10 - Model number

X - Kind of material:

1 stainless steel (316)

2 stainless steel (304)

3 brass (C37800)

4 brass (CuZn36Pb2As)

Y - 0 without cap

1 silicone protection cap

2 stainless steel protection cap

System Type:

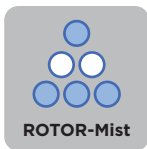
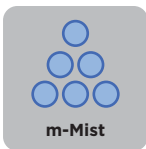

Application:



NCSFH 10.2.0



NCSFH 10.1.1



NCSFH 10.1.2

TECHNICAL PARAMETERS

Total flow surface	: 4.7 mm
Basic extinguishing media	: Water, gas and water (ROTOR)
Net filter opening	: 0.4 x 0.4 mm
Connection size	: " BSP ext.
Inlet pressure	: 6 - 16 bar
Number of orifice pairs	: 4
Head weight	: 0.2 kg
Protection cap	: Silicon cap Cat. No. - NA003 SS cap Cat. No. - NA001

TECHNICAL DETAILS

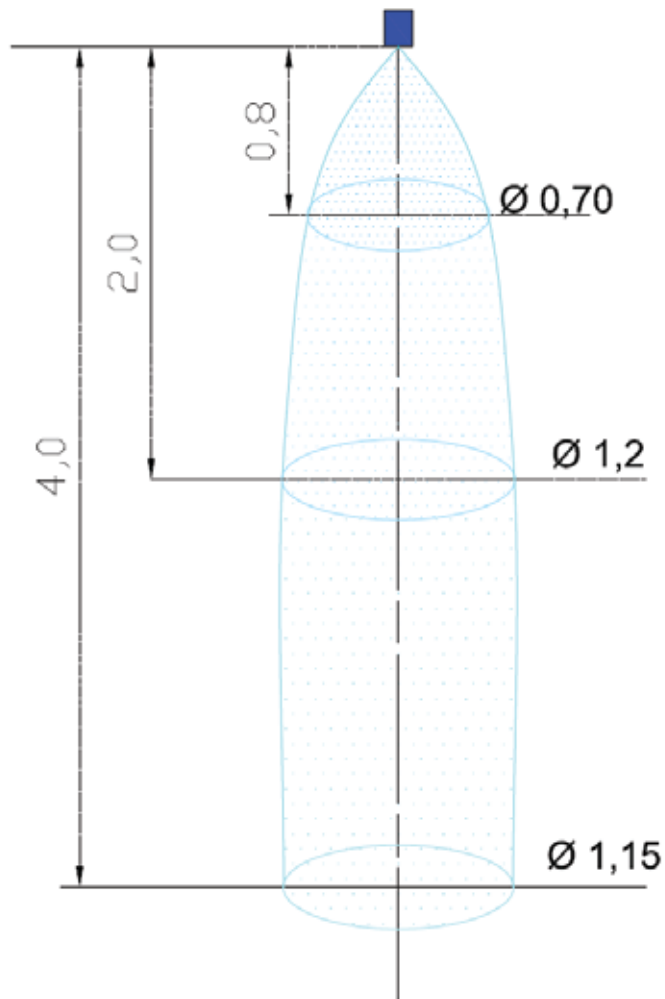
ROTOR MIST SYSTEM - MIST STREAM

ROTOR MIST SYSTEM - MIST STREAM PARAMETERS

Initial pressure of work [bar]	: 15
Droplet size D_v [μm]	: 45 - 7t5
The minimum distance required to develop a stream of water mist [m]	: 0.4
Effective stream range*** [m]	: 2.3

*May vary $\pm 5\%$. | **Range of horizontal stream | ***Measurement in 30 second of action.

Our products are being constantly developed and improved, therefore we reserve the right to change technical specifications without prior notice.

NCSFH 11 Nozzle Data Sheet

Full description: NCSFH 11.X.Y

NCSFH - Net Filter Circle Single Fluid Head

11 - Model number

X - Kind of material:

1 stainless steel (316)

2 stainless steel (304)

3 brass (C37800)

4 brass (CuZn36Pb2As)

Y - 0 without cap

1 silicone protection cap

2 stainless steel protection cap

System Type:

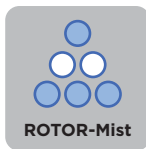
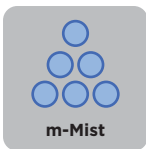

Application:

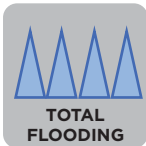

NCSFH 11.1.0



NCSFH 11.1.1

NCSFH 11.1.2

TECHNICAL PARAMETERS

Total flow surface	: 3.7 mm
Basic extinguishing media	: Water, gas and water (ROTOR)
Net filter opening	: 0.4 x 0.4 mm
Connection size	: " BSP ext.
Inlet pressure	: 6 - 16 bar
Number of orifice pairs	: 4
Head weight	: 0.2 kg
Protection cap	: Silicon cap Cat. No. - NA003 SS cap Cat. No. - NA001

TECHNICAL DETAILS

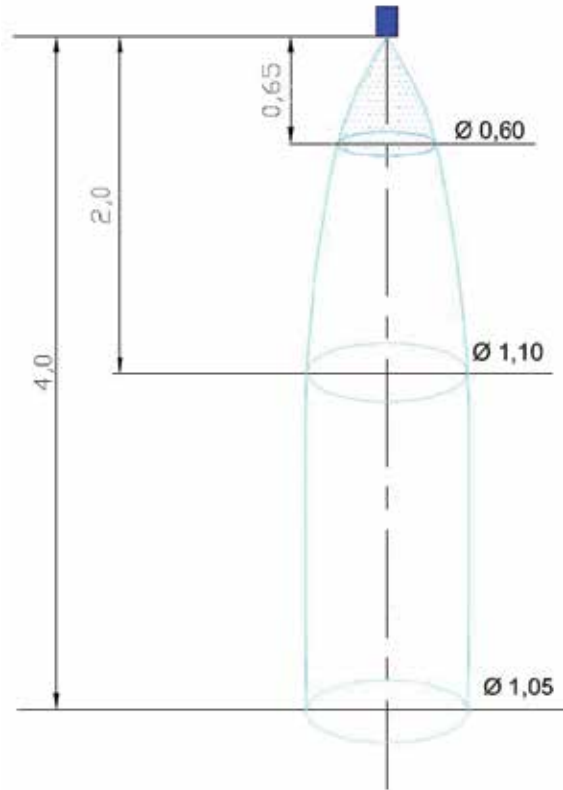
ROTOR MIST SYSTEM - MIST STREAM

ROTOR MIST SYSTEM - MIST STREAM PARAMETERS

Initial pressure of work [bar]	: 15
Droplet size D_v [μm]	: 40 - 70
The minimum distance required to develop a stream of water mist [m]	: 0.3
Effective stream range *** [m]	: 2.1

*May vary $\pm 5\%$. | **Range of horizontal stream | ***Measurement in 30 second of action.

Our products are being constantly developed and improved, therefore we reserve the right to change technical specifications without prior notice.

Operating Principle

In case of an automatic or manual actuation of the detection system, the supply unit begins to feed the medium into the fire extinguishing section. The rotors installed in cylinders produce a mixture of water and nitrogen, which flows in a rotor manner. It then flows out of the cylinder, through the manifold, into the main system pipe and further, via the pipeline, into the heads located under the hood. The nozzles generate a flow of mist, which covers the entire area.

The mist ejected from the nozzle forms a shape similar to a cone, whereas the joined streams create a mist curtain. The large area of dispersed Watermist enables fast and very efficient transfer of heat from the site being on fire. The collection of heat by the evaporating mist forms the basis of the system's fire extinguishing efficiency. The heads placed behind the filters and in the ventilation duct supply the extinguishing mist, which simultaneously cuts off the oxygen supply and cools the protected areas.

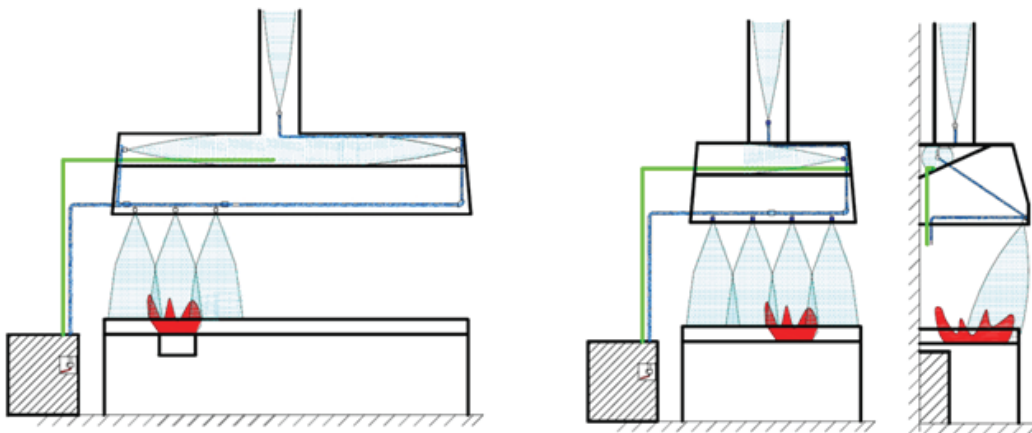

Advantages of the Watermist Kitchen Suppression System



Elimination of post-fire losses caused due to flooding or usage of chemical extinguishing agents.



Highly efficient at putting out fires.



Fast distribution of mist due to high kinetic energy of the jet.



Minimal water consumption.



No risk of cracks in construction, housings and steel components.



No thermal shock.



Safe for people and property due to low pressure of water and gas.



The Watermist Kitchen Suppression System has been designed to protect any type of professional cooker used in restaurants, canteens, large catering areas, industrial kitchens, and on ships and yachts. Owing to the special ability of Watermist to fight Class A, B and F fires, the system can also be employed to protect small and large fryers, fried food stands and similar food processing equipment.

CUSTOMIZED SOLUTIONS

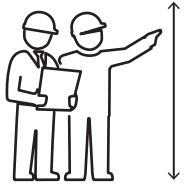

First, our Safety Consultants will visit your premises and help you calculate the length of the kitchen hood you wish to protect.



Depending on the dimensions, a customized design is made.



Finally, the Installation Team oversees installation and testing.

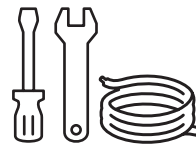

Post installation, Ceasefire's Specialised Services Division maintains and services the system.



The big advantage here is that the variant you choose will have a fixed price. Any further costs involved in customising the system or adding components will be taken care of by us, giving you complete peace of mind.



The logo consists of the words "CEASE" and "FIRE" stacked vertically in a bold, sans-serif font, enclosed within a square border.The text "WORLD SERIES" is displayed in a bold, sans-serif font. Behind the text is a faint, dotted map of the world.

WET CHEMICAL BASED KITCHEN SUPPRESSION SYSTEM





ULTRA PLUS SERIES / ENGINEERED

WET CHEMICAL BASED KITCHEN SUPPRESSION SYSTEM

**CERTIFIED BY LPCB TO
LPS 1223 STANDARD**



Hazardous oil and grease fires in kitchens take place due to overheating of oil in the temperature range of 350°C - 380°C. Fires are further enhanced by the accumulation of oil deposits in the enclosure behind the filter and the exhaust ducts of the kitchen hood over time due to cooking activities.

Several reasons can be attributed to kitchen fires, from temporary distraction by the user to

complete absence of attention to cooking appliances and vessels during cooking to malfunctioning of automated temperature control equipment in electrical deep fat fryers.

This is where the Ceasefire Wet Chemical Kitchen Suppression System comes in. This automated kitchen fire suppression system detects and kills a fire, even when no one is around.



How The System Protects

The Wet Chemical based Kitchen Suppression System incorporates both manual and automatic protection by a pneumatic detection and actuation technique.

All sensitive areas susceptible to fire such as fire due to overheated cooking oil in vessels/deep fat fryer and oil residual deposits in the extraction system of kitchen hoods are covered by a pressurised heat sensing tube. The heat sensing tube is connected to the head of the indirect low

pressure valve mounted on the top of pressurised agent container.

In case of fire, the heat sensing tube punctures at a pre-determined temperature, releasing the pressure of the tube and activating the indirect valve. The extinguishing agent thus released is spread through distribution piping from the nozzle provided to cover the kitchen hood, vessels, plenum and duct.

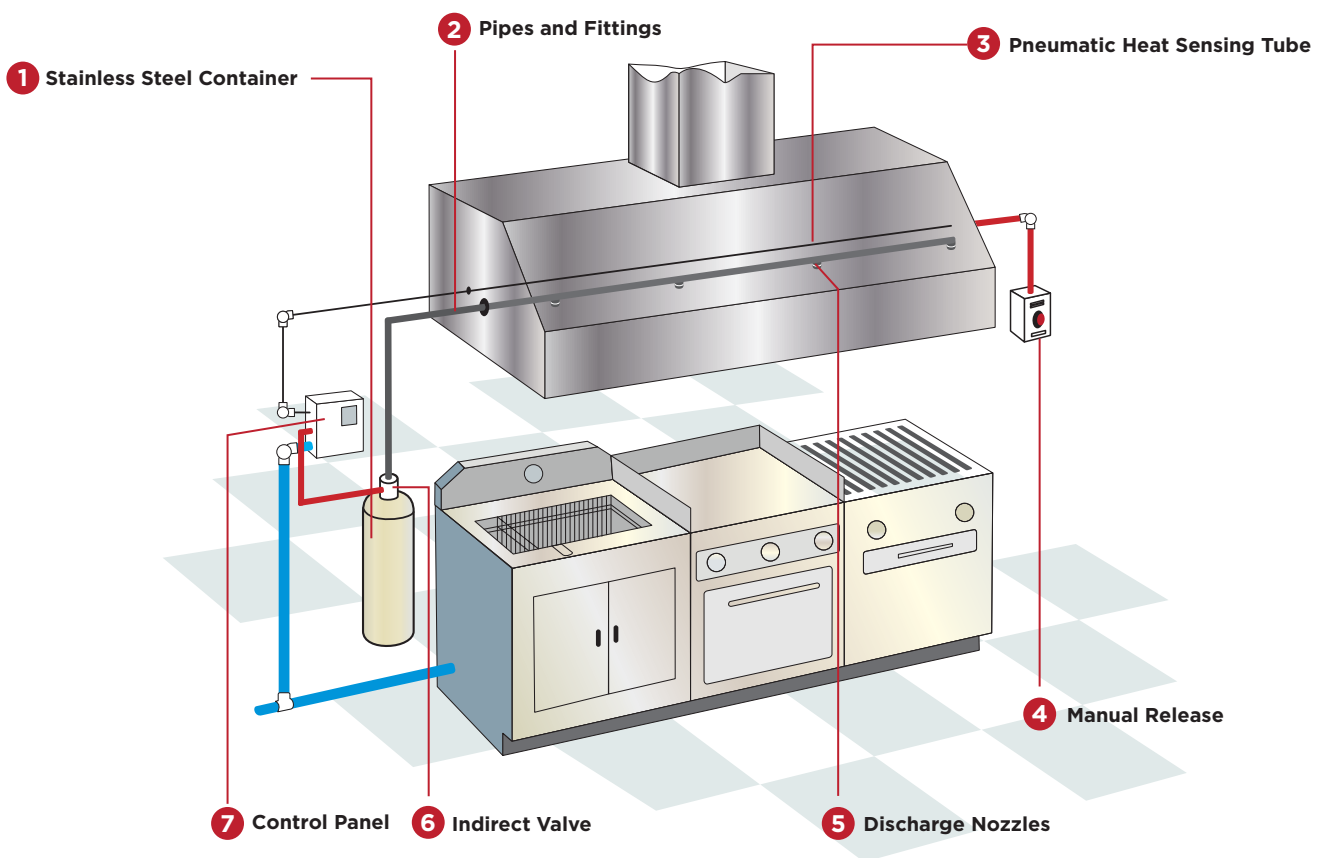

How The Agent Works

The extinguishing chemical is a wet chemical based foaming agent named CF lite. CF lite is a highly concentrated formulation of the extinguishing agent that makes it effective against Class A, B and kitchen fires.

In contrast to normal Class B fires where temperatures in the range of 350°C-380°C are observed only in the burned fuel or their vapour, the oil used in cooking is itself at this high temperature.

The extinguishing agent has a blanketing effect on the flames, which cools the oil to below its self-ignition point, thereby killing fire..

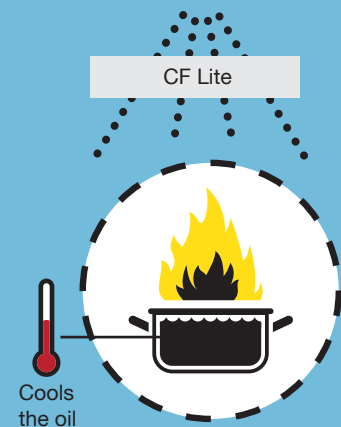









CEASEFIRE'S WET CHEMICAL BASED KITCHEN SUPPRESSION SYSTEM GIVES YOU MORE:

- LPCB Certified System
- No flooding-related collateral damage
- Fights Class A, B and F (cooking oil) fires
- Its heat-sensitive tube offers superior uniform protection as compared to conventional Point Detector-based Systems
- Available in 11.5 liters, 18 liters and 27 liters



Features of the Wet Chemical Based Kitchen Suppression System

	24-hour Protection - Automatic detection and actuation controls ensure fire protection is always 'up'.
	Stored Pressure Technology - Stainless steel containers hold the wet chemical under stored pressure. This not only ensures instant activation, but also provides the convenience of checking the readiness of the system by the mere observation of the pressure gauge. If the needle is in the green zone, the system is ready for action
	Multiple Triggers - The system can be triggered either by the manual actuation system or the automatic detection system.
	Highly Effective - Wet Chemical prevents re-ignition by cooling down the temperature of the heated oil.
	Unobtrusive Design - Flexible piping configurations allow for a streamlined design and convenient installation that won't interfere with kitchen workflow.

	Highly Flexible - Ceasefire's Kitchen Suppression System's flexible configuration and design can easily accommodate changes to the layout of appliances or the expansion of the cooking area.
	Highly Reliable - A fully assembled and 100% tested Mechanical Control Head ensures reliable operation. Pressure gauges on the steel cylinders mark the gas levels, allowing maintenance staff to replenish it whenever required. Protective chrome nozzle covers keep the nozzles free of contamination and blockages caused by grease or other cooking by-products.
	LPCB Certified System
	3 Variants - Available in three variants - 11.5 liters, 18 liters and 27 liters.

Wet Chemical Based Kitchen Suppression System Components

1. AGENT CONTAINER

The size and content of the stainless steel cylindrical agent containers depend upon the number of nozzles selected. Agent containers are available in three sizes:

11.5 liters capacity | **18 liters capacity** | **27 liters capacity**

The agent volume has been selected by the number of nozzles estimated to 1.5 liters per nozzle discharge.

2. CYLINDER VALVE

This ILP valve is the main component of an indirectly working extinguishing system in connection to the Ceasefire heat sensing tube. If the sensor detects a fire, the valve is triggered and expels the extinguishing agent from the pressure vessel through a separate

discharge line. The valve reacts to a drop in pressure inside the heat sensing tube and opens the valve outlet. Because of the indirect function principle, the system may also be triggered and activated manually or electromagnetically.

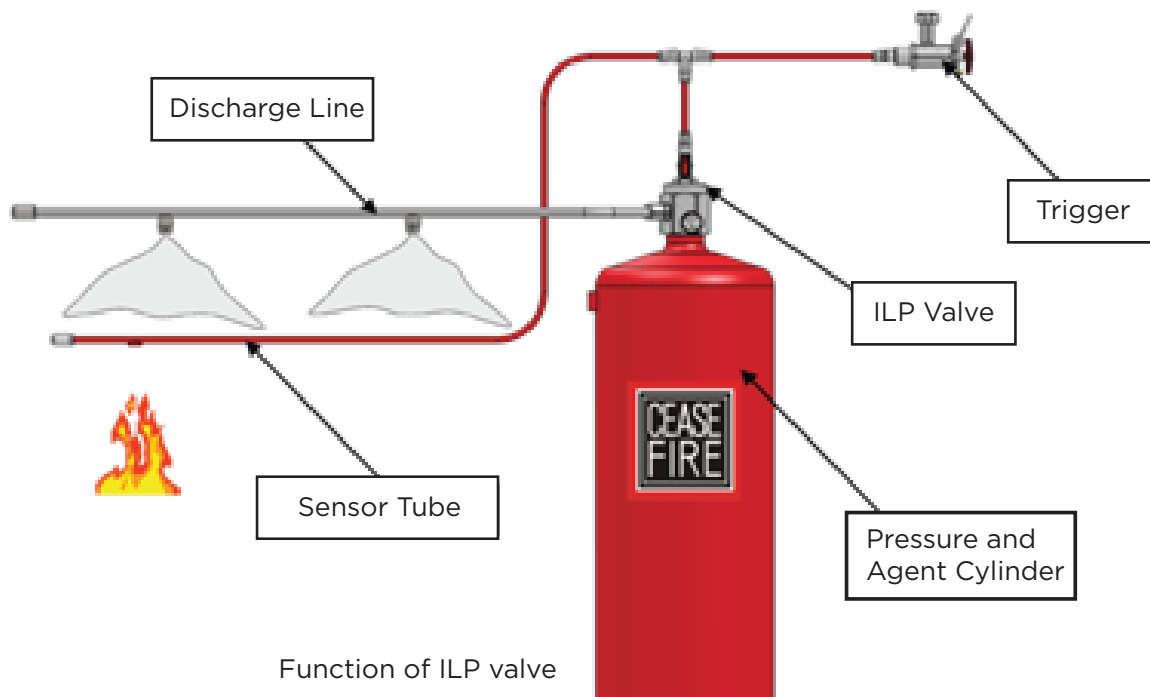

3. EXTINGUISHING AGENT



Developed after extensive research by Ceasefire, the extinguishing agent has a significant influence not only on the extinguishing result (especially in the case of grease fires) but also on factors such as the corrosive behaviour and performance.

CF Lite is a concentrated class F or Class K fire fighting wet chemical based extinguishing agent. This powerful agent fights all types of kitchen hood fire effectively.

The powerful agent brings down the agent quantity requirement to 1.5 ltr per nozzle making the system more efficient.

Using CF Lite a larger hood area can be protected using the same agent cylinder size because it supports more number of nozzles with the same quantity of agent.

4. CEASEFIRE HEAT SENSING TUBE

In the Wet Chemical Kitchen Suppression System, the standard fire detection device is the Ceasefire heat sensing tube. Ceasefire's heat sensing tubes are made of high-tech plastic and were developed especially for the installation and application in automatic fire extinguishing systems.

The prescribed operating pressure is applied to the heat sensing tube after the proper installation. Due to the thermal material properties and the inner over-pressure, the heat sensing tube will burst when touched by a flame or subjected to an excessive heat increase, and therefore functions as a reliable detector in the case of a fire.



5. MANUAL ACTUATOR

Manual triggers are installed in or at the end of the detection line and simulate a burst of the heat sensing tube when actuated. The drop of pressure thus generated will trigger the valve.

To actuate the manual trigger, pull the safety pin and press the red strike knob.

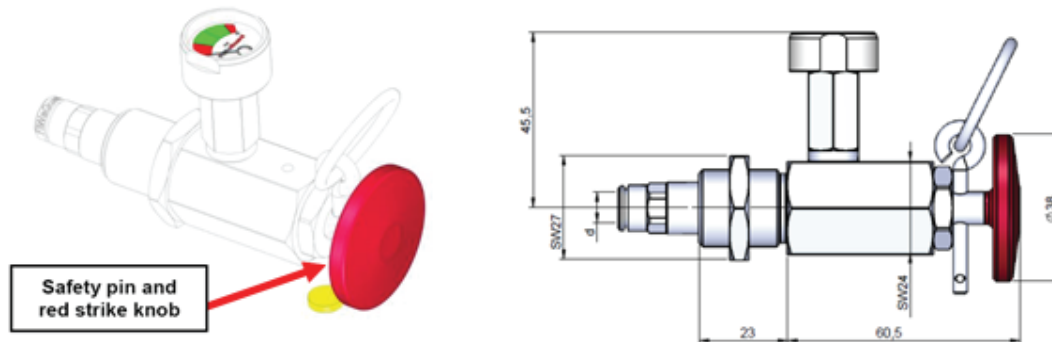

The installation of a manual trigger is mandatory.

6. EXTINGUISHING NOZZLES

The number of nozzles needed for a system depends on the circumstances and the type of equipment in the kitchen.

Full cone nozzle 40° | **Full cone nozzle 15°**

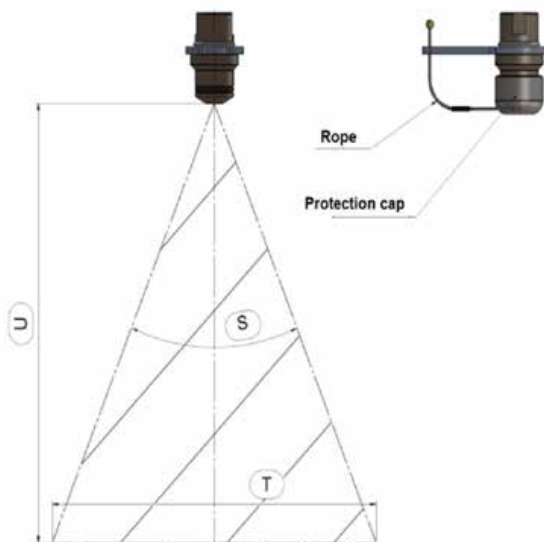

The nozzles are protected against the intrusion of dirt and grease by protection caps. However, the nozzles must be kept absolutely clear of dirt and obstructions during installation. When the system is activated, the protection caps are blown off and do not impede the dispersal of the extinguishing agent.

The nozzles must be selected according to the local circumstances (hood length) and aligned accordingly.

7. PIPES, FITTINGS

Stainless steel pipe of **10 mm diameter** (inner diameter of 8 mm) with compression fittings are used.

8. AUTOMATIC FIRE DETECTION

Each Ceasefire kitchen fire extinguishing system is fitted with a pneumatic heat sensing tube as a fire detector. In the event of a fire, the tube will react to the increasing heat and burst. The resulting pressure drop activates the cylinder valve (**ILP**) and the extinguishing agent is expelled through the extinguishing line.

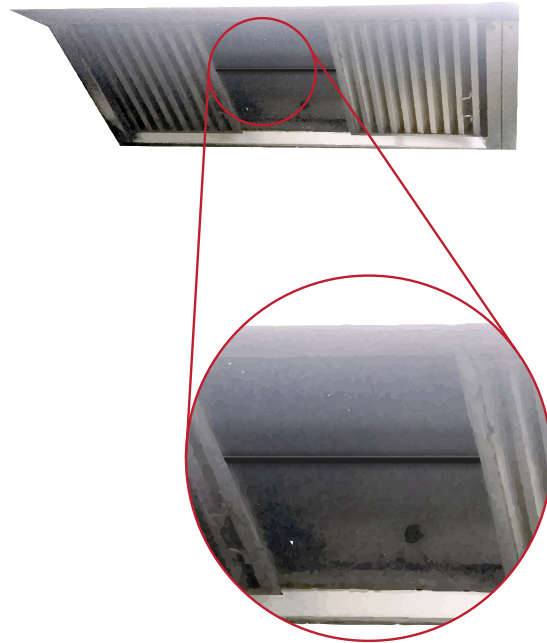

9. MANUAL SYSTEM ACTUATION



In case the kitchen personnel or someone else detects a fire before the sensor hose has reacted, he or she can trigger the activation manually. There are two manual actuation options available. The silver safety pin must be pulled, and the red strike knob must be pushed deeply and firmly. These triggers are mounted at the end or in line with the sensor hose.

10. OPTIONAL CONTROL PANEL

The Control Panel not only helps monitor the readiness of your kitchen suppression system, which ensures that you're not left high and dry in an emergency situation, but also raises the alarm.



- **Activates alarm**
- **Compatible with third party systems**
- **Helps check the readiness of your kitchen suppression system**

CUSTOMIZED SOLUTIONS

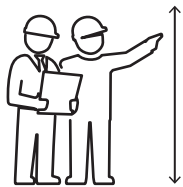

First, our Safety Consultants will visit your premises and help you calculate the length of the kitchen hood you wish to protect.



Depending on the dimensions, a customized design is made.



Finally, the Installation Team oversees installation and testing.



Post installation, Ceasefire's Specialised Services Division maintains and services the system.



The big advantage here is that the variant you choose will have a fixed price. Any further costs involved in customising the system or adding components will be taken care of by us, giving you complete peace of mind.



WORLD SERIES

TECHNICAL SPECIFICATIONS

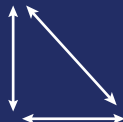



ENVIRO SERIES

WATERMIST BASED KITCHEN SUPPRESSION SYSTEM

Length of protected area (kitchen) [m]	Max. number of nozzles in the system	Number and type of cylinders			Number of rotors in the supply unit
		Total capacity of cylinder** [dm ³]	Number of cylinders	Maximum quantity of extinguishing agent (water)	
0.4 - 1.4	4 - 6	11.5	2	17	2
		27	1	19.5	2
1.4 - 1.79	5 - 7	11.5	2	17	2
		11.5	4	34	4
		27	1	19.5	2
		56	1	40	4
1.8 - 3.6	7 - 12	11.5	4	34	4
		27	2	39	4
		56	1	40	4
3.61 - 8.0	13 - 25	27	2	39	8
		56	2	80	8

VALVE	
Construction	S.S 304
Indirect low pressure valve with two outlets	Differential head pressure operation
Valve outlet thread	G1/2" (2x)
Vessel connection thread	M30 x 1.5 mm
Heat sensing tube connector to ILP	OD. 6 mm
Pressure gauge	Connection thread M10 x 1
Height	143 mm

HEAT SENSING TUBE	
Construction	Modified, Two Layer Poly Amide
Dimensions	Od-6 mm ; Id-4 mm
Permeability	10.4 Mbar L/sec (Helium)
Bending Radius	Min 100 mm

* Please check the product specifications at the time of placing your order from our website (address of which is given at the end of this catalogue). Specifications can change without notice due to our continuous R&D and product improvisation initiatives.



PIPES AND FITTINGS	
Construction	SS 304
Dimensions	Dn 10 ; Dn 15; Dn 20

NOZZLES	CSFH 08	CSFH 10	CSFH 11	CSFH 16
Construction	S.S. 304			
Maximum Horizontal Range at 6 Bar	1200 mm	1400 mm	1600mm	1300 mm
Maximum Spray Diameter at 5m	1200 mm	1200 mm	950 mm	1650 mm
Spray Distance	5 m			
Spray Form	Approximately Cone			
Flow Rate at 6 Bar	7.5 L/min	5.4 L/min	4.4 L/min	7.1 L/min
Protection	Steel cap with chain			



ULTRA PLUS SERIES

WET CHEMICAL BASED KITCHEN SUPPRESSION SYSTEM

DIMENSION / SIZE / VOLUME / TYPE / PRESSURE			
Agent container volumes	11.5 L	18 L	27 L
Part code	SM-RM1585	SM-RM1586	SM-RM1953
Indirect low pressure valve with two outputs and integrated ball valve. (ILP)	Differential head pressure operation.		
Dip tube length for agent container.	537.5mm	321mm	456mm
Internal diameter of Dip tube	ID 22.4 mm		
End connection of valve for dip tube fitting	M16 x 1.5		
Filter for dip tube (strainer)	Mesh size <1mm		
Length for agent container.	547.5 mm	331 mm	466mm
Internal Dia. for agent container.	175mm	300mm	300mm
Max agent content for agent container.	9 Litres	14.5 Litres	22 Litres
Heat sensing tube connector to IPL	Dia. 6mm		
Output for distribution piping.	G ¼"		
Operating temperature range	0° to 65° C		
Pressure gauge for agent container pressure.	Maintained at 19 bar relaxation of +/- 0.25 bars.		
Operating pressure	Min. 17bar -23.7 bar Max.		
Agent propellant / Agent container pressurizing.	Nitrogen (N2)		
Agent container color.	Ivory/Red/Bare stainless steel		
Agent container material.	Stainless steel.		
Agent container head.	M30x1.5		

VALVE	
Construction	S.S. / Brass
Indirect low pressure valve with two outlets and Integrated ball valve (ILP)	Differential head pressure operation
Valve outlet thread	G1/4" (2x)
Vessel connection thread	M30 x 1.5 mm
Dip tube thread	M16 x 1.5 mm
Heat sensing tube connector to ILP	OD. 6 mm
Pressure gauge	Connection thread M10 x 1
Electronic monitoring of lever position	Optional
Height	120 mm (Inclusive of 16 mm thread)

NOZZLES	F0060014	F0060015
Construction	S.S. / Brass	
Spray Angle	40 Degree	15 Degree
Spray Cone Diameter	1100 mm	500 mm
Spray Distance	1350	1000
Spray Form	Full Cone	
Flow Rate	Approx 3L/min	
Protection	Steel Cap With Rope	

PIPES AND FITTINGS	
Construction	SS 304
Dimensions	Od-10 mm; Id-8 mm
Connection Hose	Rubber Hose Work Pressure 40 Bars

HEAT SENSING TUBE	
Construction	Modified, Two Layer Poly Amide
Dimensions	Od-6 mm ; Id-4 mm
Bending Radius	Min 100 mm

EXTINGUISHING AGENT	
Physical State	Liquid
Colour	Brownish
Odor	Typical
Boiling Point	> 100 Degree Centigrade
Ignition Point	> 100 Degree Centigrade
Density At 20 Degree Centigrade	1.02 G/milliliter
Water Solubility	Unlimited in water
Ph-value (G/liter water °C):	Approximately 7.5
Concentration Mix In Water	10 Percent



Optional Control Panel

This 4 Channel Quick Response System Controller integrates 4 cylinder monitoring and control functions. This system comes with a front display and keypad option which allows programming and viewing options at the panel.









OPERATING FEATURES

The Control Panel not only helps monitor the readiness of your kitchen suppression system, which ensures that you're not left high and dry in an emergency situation, but also raises the alarm.



- 4 Cylinders' Valve and Pressure Switch Status Monitoring.
- Wide Operating Voltage SMPS with 150-300V Range.
- User-friendly Interface with LCD Display.
- Programmable sense delay timing for sounder and relay activation maximum up to 5 sec.
- Relay outputs for Hooter and Lamp indication on detection of fire.

KEY FUNCTIONS

 RESET	RESET : The reset key resets faulty conditions. The cylinder valve open/close conditions reset. The pressure switch open does not have an auto reset, it resets by pressing the reset key.	 8 TUV	DOWN ARROW: The setup menu display can be scrolled up by pressing this key. Also switching on the unit by pressing this key continuously for 10 seconds resets the password to default factory settings.
 TEST	TEST : Pressing this key ensures diagnosis of the system.	 2 ABC	UP ARROW: The setup menu display can be scrolled up by pressing this key. Also, the state of AC supply and battery will be displayed on the screen.
 ALARM MUTE	ALARM MUTE : Whenever a fault or fire occurs, the alarm relay turns ON . Silencing the alarm/hooter can be done by pressing this key.	 6 MNO	RIGHT ARROW: To scroll the cursor to the right along with the shift key.
MENU ENTER	MENU/ ENTER : User/operator can enter into the setup menu by pressing this key.	 4 GHI	LEFT ARROW: To scroll the cursor to the left along with the shift key.
1 Ecs	ESC: To exit to the main screen, press ESC key.		
 SHIFT	SHIFT : Shift + left/right arrow key pressed together enables the shifting of the cursor respectively, so as to edit parameter values.		



SYSTEM BLOCK DIAGRAM

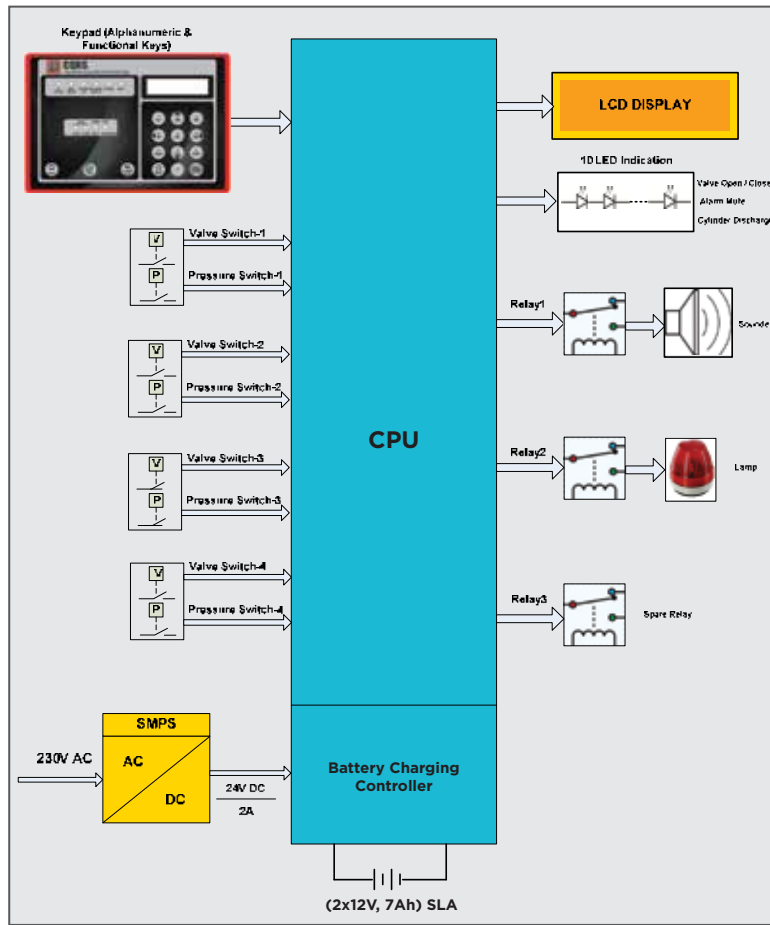

WIRING DIAGRAM

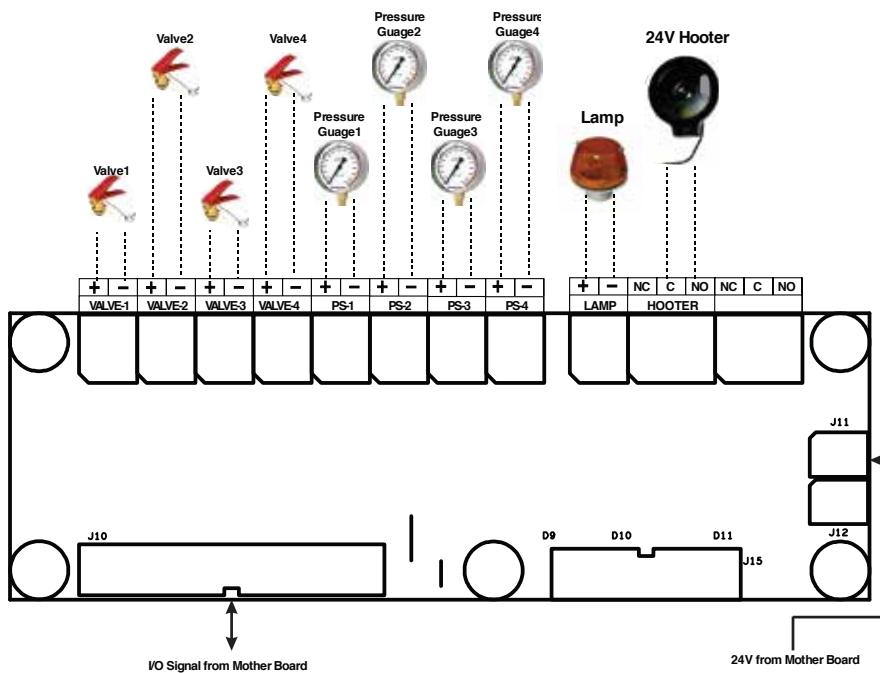



WORLD SERIES

TECHNICAL DIAGRAMS



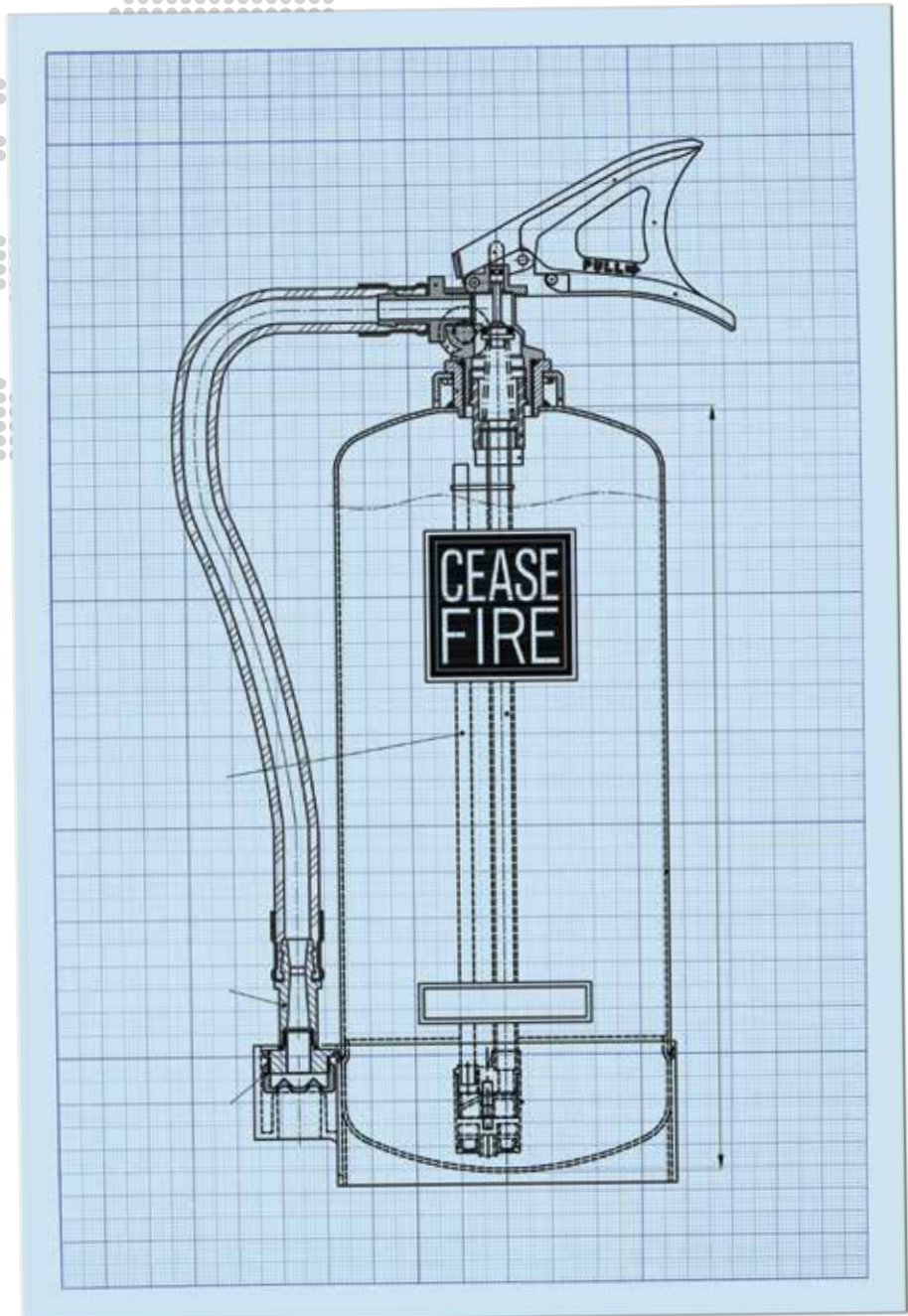

THE WATERMIST KITCHEN SUPPRESSION SYSTEM

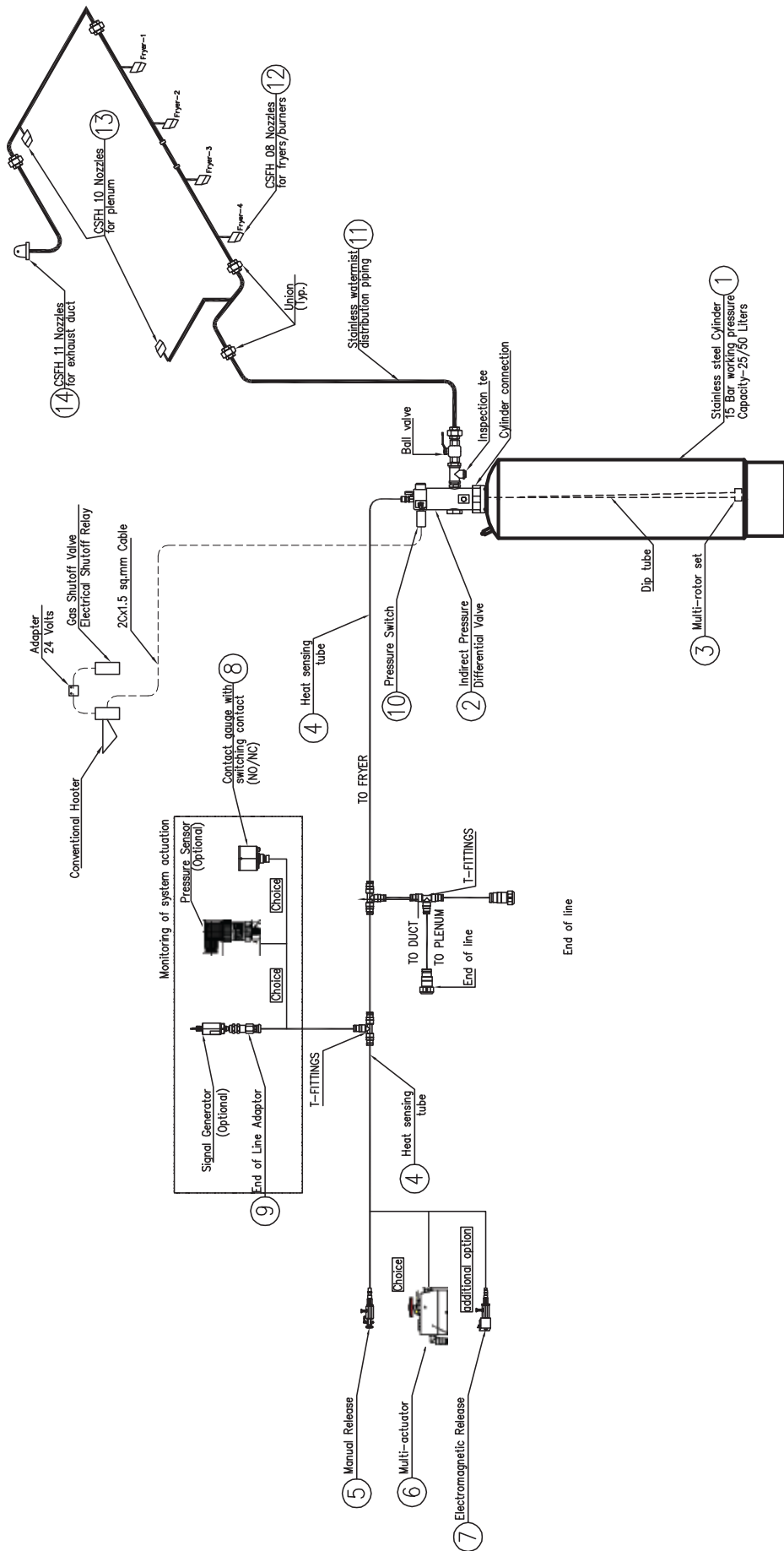

End of line



THE WET CHEMICAL KITCHEN SUPPRESSION SYSTEM

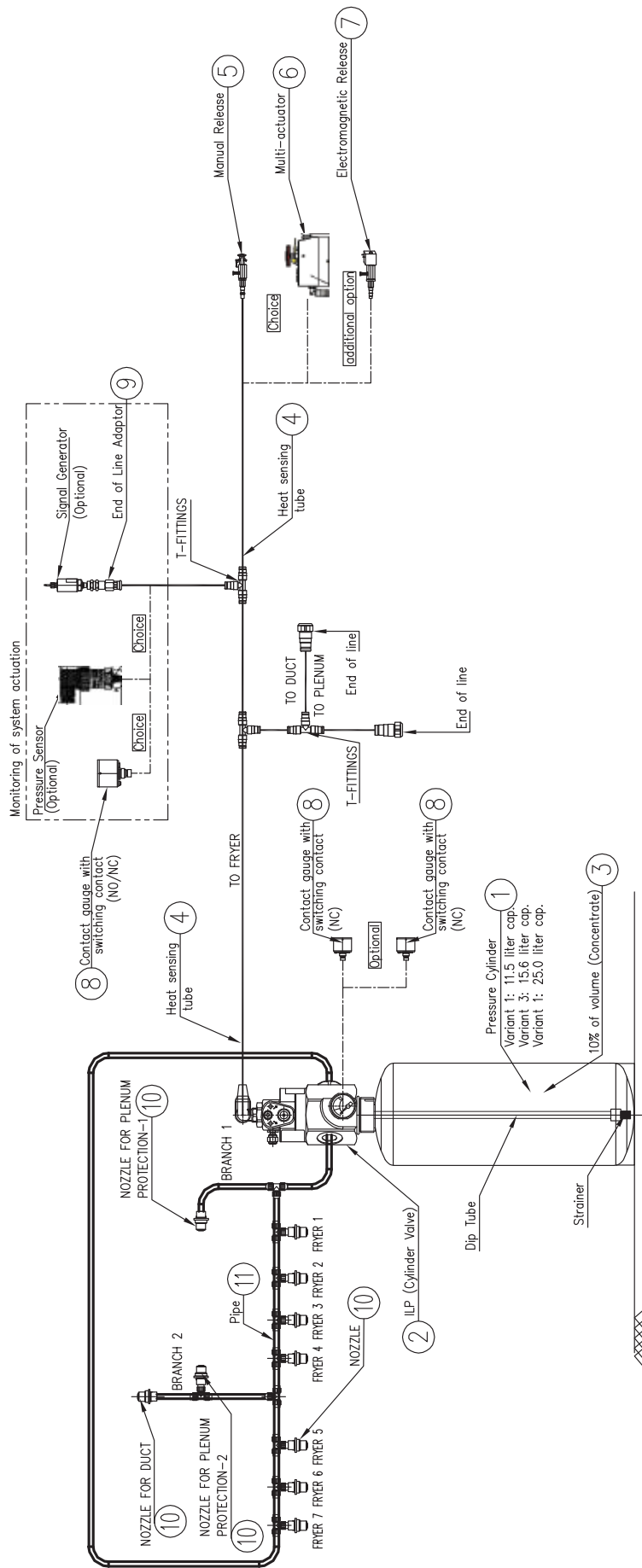

WATERMIST-BASED PORTABLE EXTINGUISHERS 2 Ltr.

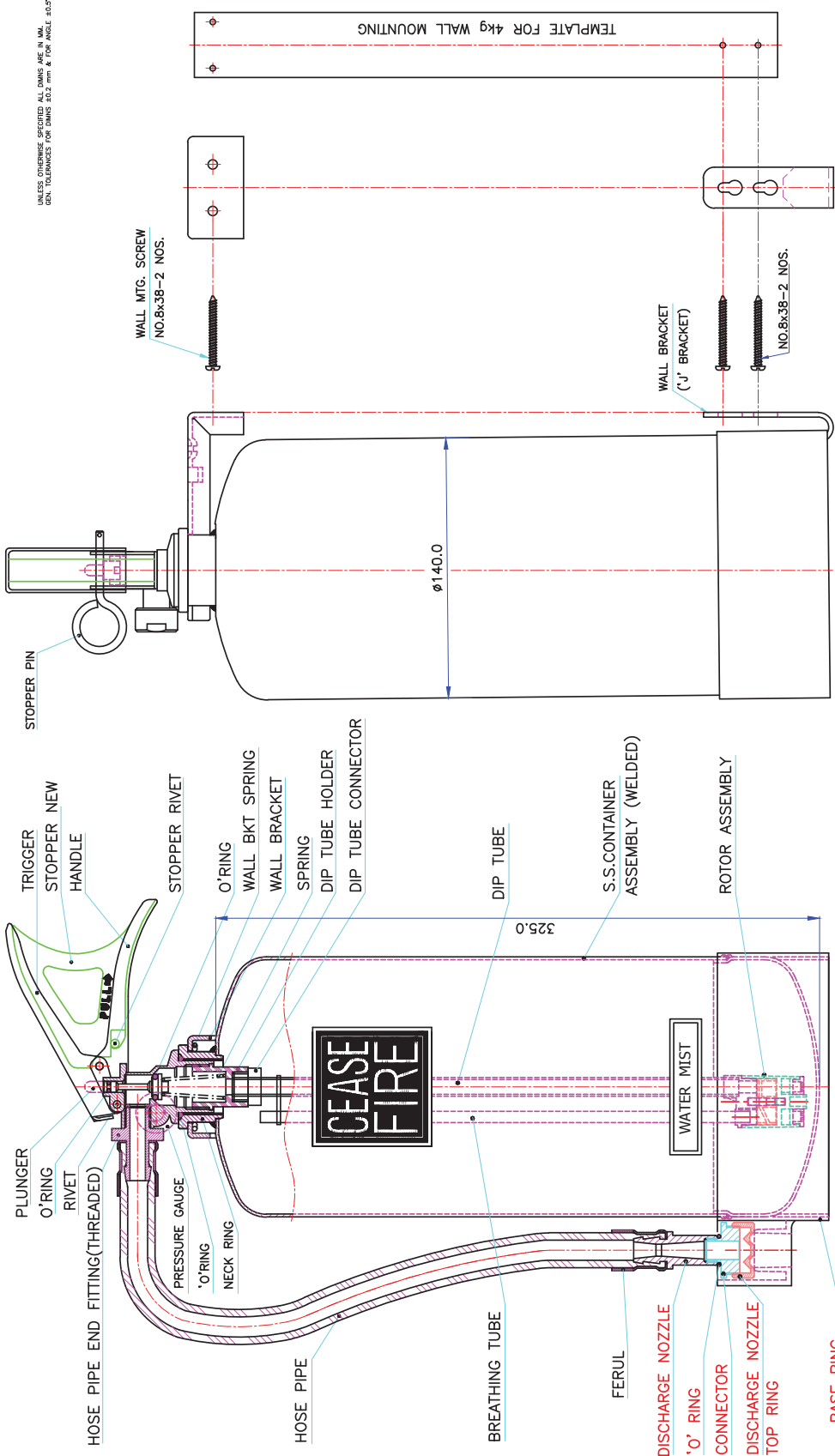

2 Ltr. WATER MIST

R.H.S.VIEW

ELEVATION (PARTIAL SECTION)

CEASEFIRE INDUSTRIES LTD. E-6, Saket Indl. Area, Dehradun, Uttarakhand	
DATE	SIGN
10/11/11	ARP
DRWN	TITLE
TRCD	G.A. OF PORTABLE FIRE EXTINGUISHER
CHKD	2 Ltr. WATER MIST-STORED PRESSURE
APPD	SCALE - NTS
	QTY./UNIT-
	MATERIAL- FINISH -
	DRG.No. CF/SP2-H ₂ O MIST/GA/00

PRODUCT CONTENT

- 1-WATER - 2 Ltr.
- 2-CHARGED WITH NITROGEN

WATERMIST-BASED PORTABLE EXTINGUISHERS 3 Ltr.

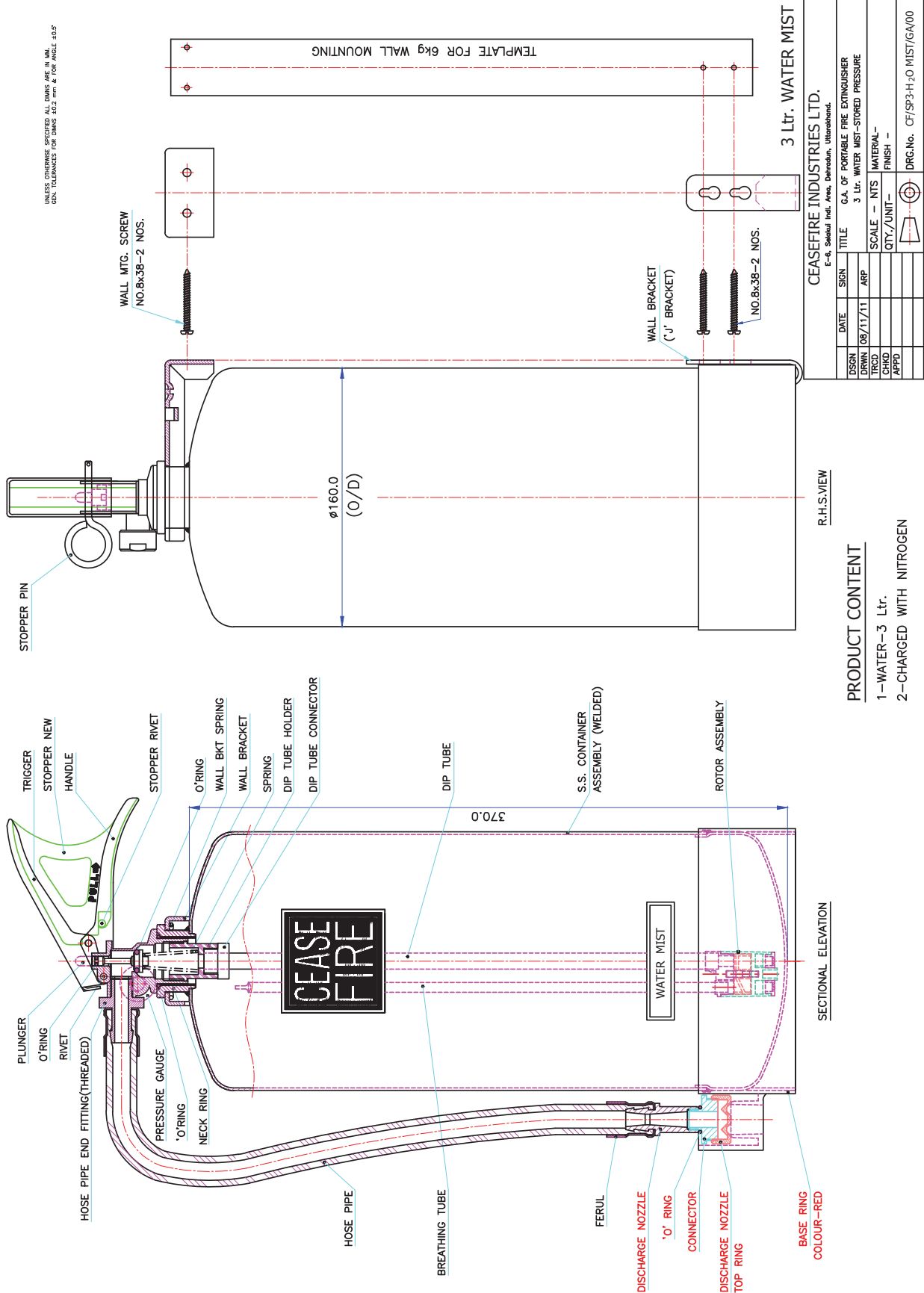

DATE	SIGN	TITLE	G.A. OF PORTABLE FIRE EXTINGUISHER
08/11/11	ARP	3 Ltr. WATER MIST-STORED PRESSURE	
DRWN		SCALE - NTS	MATERIAL-
TRCD		QTY./UNIT-	FINISH -
CHKD			
APPD			

CEASEFIRE INDUSTRIES LTD.
E-6, Sakal Ind. Area, Dehradun, Uttarakhand.

WATERMIST-BASED PORTABLE EXTINGUISHERS 6 Ltr.

UNLESS OTHERWISE SPECIFIED ALL DIMS ARE IN MM.
GEN. TOLERANCES FOR DIMS ±0.2 mm & FOR ANGLE ±0.5°

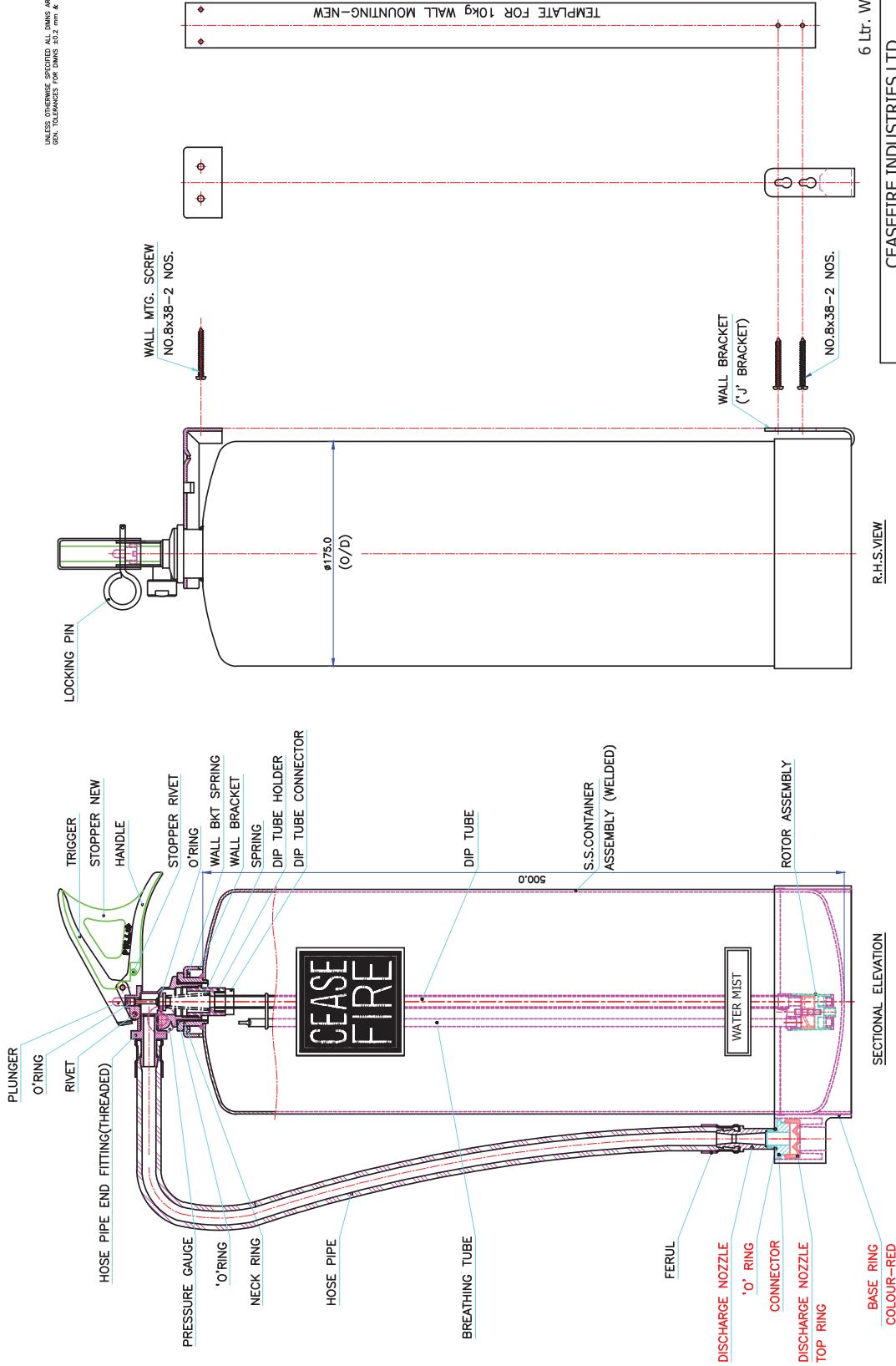

6 Ltr. WATER MIST

R.H.S.VIEW

SIGN		TITLE	
DATE		G.A. OF PORTABLE FIRE EXTINGUISHER	
DSSN	DRWN	TRGD	CHKD
APPD	QTY./UNIT	FINISH	DRG.No. CF/SP6-H ₂ O MIST/GA/00
E-6, Sakdai Ind. Area, Dehradun, Uttarakhand.		CEASEFIRE INDUSTRIES LTD.	
10/11/11		6 Ltr. WATER MIST-STORED PRESSURE	
ARP		SCALE - NTS	
		MATERIAL-	
		QTY./UNIT-	
		FINISH -	

PRODUCT CONTENT

- 1 - WATER - 6 Ltr.
- 2 - CHARGED WITH NITROGEN

WET CHEMICAL-BASED PORTABLE EXTINGUISHERS 3 Ltr.

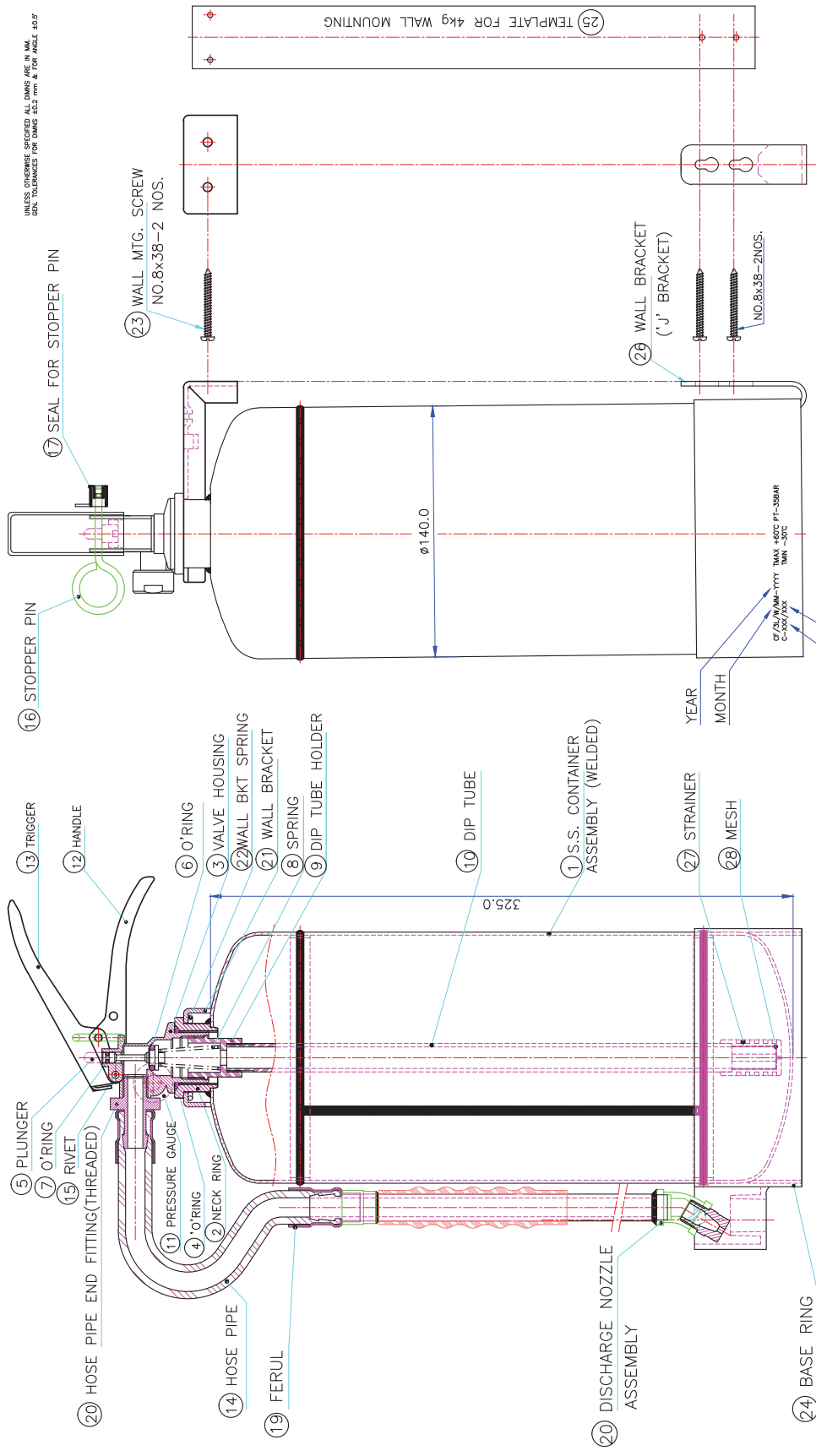

DATE		SIGN	TITLE	
29/12/15		ARP	G.A. OF PORTABLE FIRE EXTINGUISHER	
DRWN		TRCD	3 Ltr. WET CHEMICAL-STORED PRESSURE	
CHKD		APPD	SCALE - NTS	
			MATERIAL - FINISH -	
			DRG.No. CF/SP-WC3/GA/00	

PRODUCT CONTENT
 1 - WET CHEMICAL - 3 Ltr.
 2 - CHARGED WITH NITROGEN

NOTE:-
 1 - FOR PART LIST REFER DOC. NO. CF/PL/SP-WC3/00
 2 - MARKING ENGRAVED ON FOOT RING OF CONTAINER

WET CHEMICAL-BASED PORTABLE EXTINGUISHERS 6 Ltr.

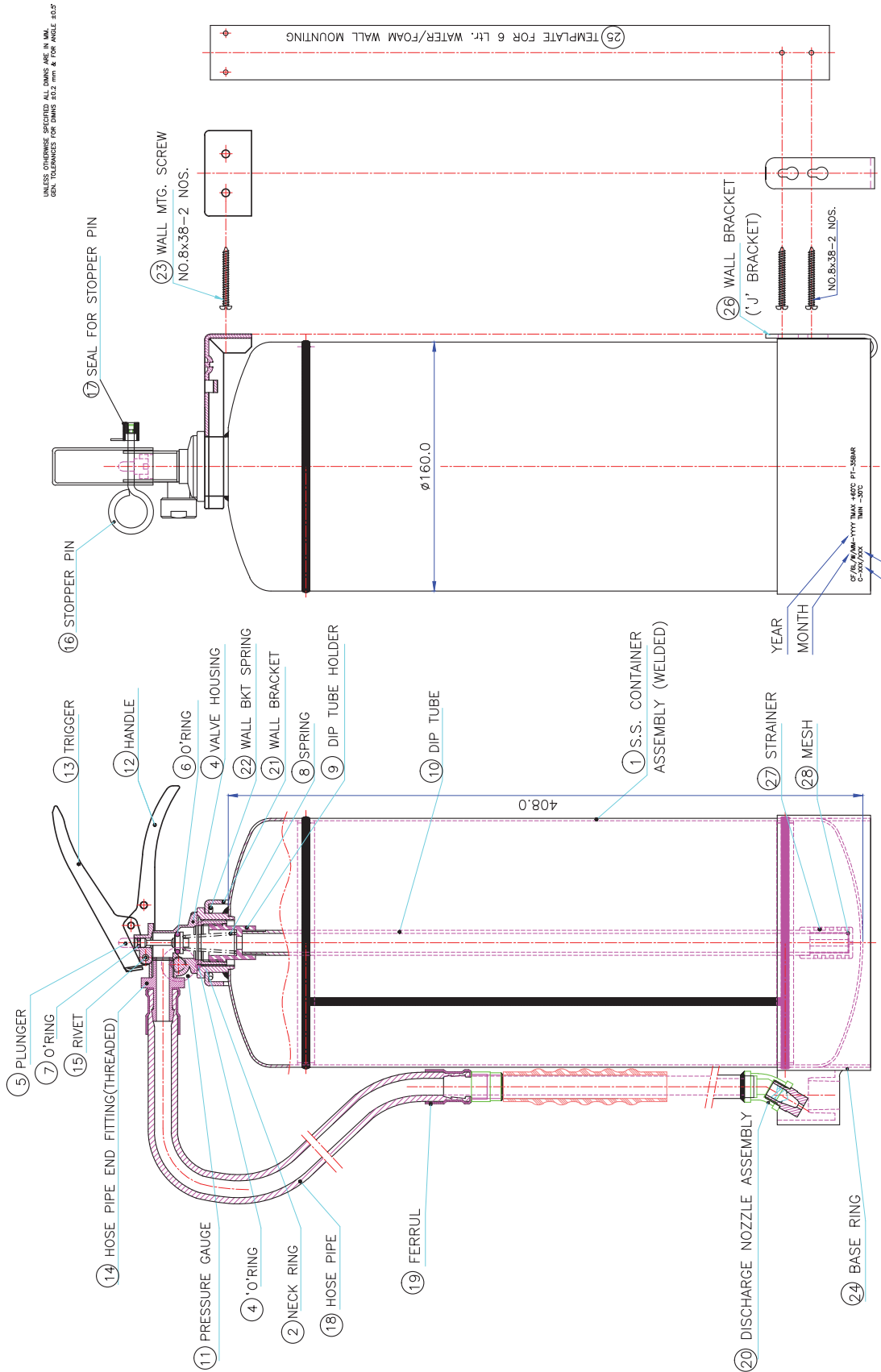

UNLESS OTHERWISE SPECIFIED ALL DIMS ARE IN MM.
GEN. TOLERANCES FOR DIMS 0.2 mm & FOR ANGLE 0.5°

DATE		DESIGN	SCALE	DRG. NO.
07/06/2000		CF/PL/SP	1:1	CF/SP-WC6/GA/00
TITLE		6 Ltr. WET CHEMICAL-STORED PRESSURE		
MATERIAL		S.S.		
FINISH		N/A		
APPD.		N/A		

CEASFIRE INDUSTRIES LTD.
 6 Ltr. WET CHEMICAL-STORED PRESSURE
 PRODUCT CONTENT
 1 - WET CHEMICAL - 6 Ltr
 2 - CHARGED WITH NITROGEN

BATCH NUMBER
 SERIAL NUMBER

NOTE:-
 1 - FOR PART LIST REFER DOC. NO. CF/PL/SP-WC6/00
 2 - MARKING ENGRAVED ON FOOT RING OF CONTAINER

WET CHEMICAL-BASED PORTABLE EXTINGUISHERS 9 Ltr.

UNLESS OTHERWISE SPECIFIED ALL DIMS ARE IN MM.
GEN. TOLERANCES FOR DIMS ±0.2 mm & FOR ANGLE ±0.5°

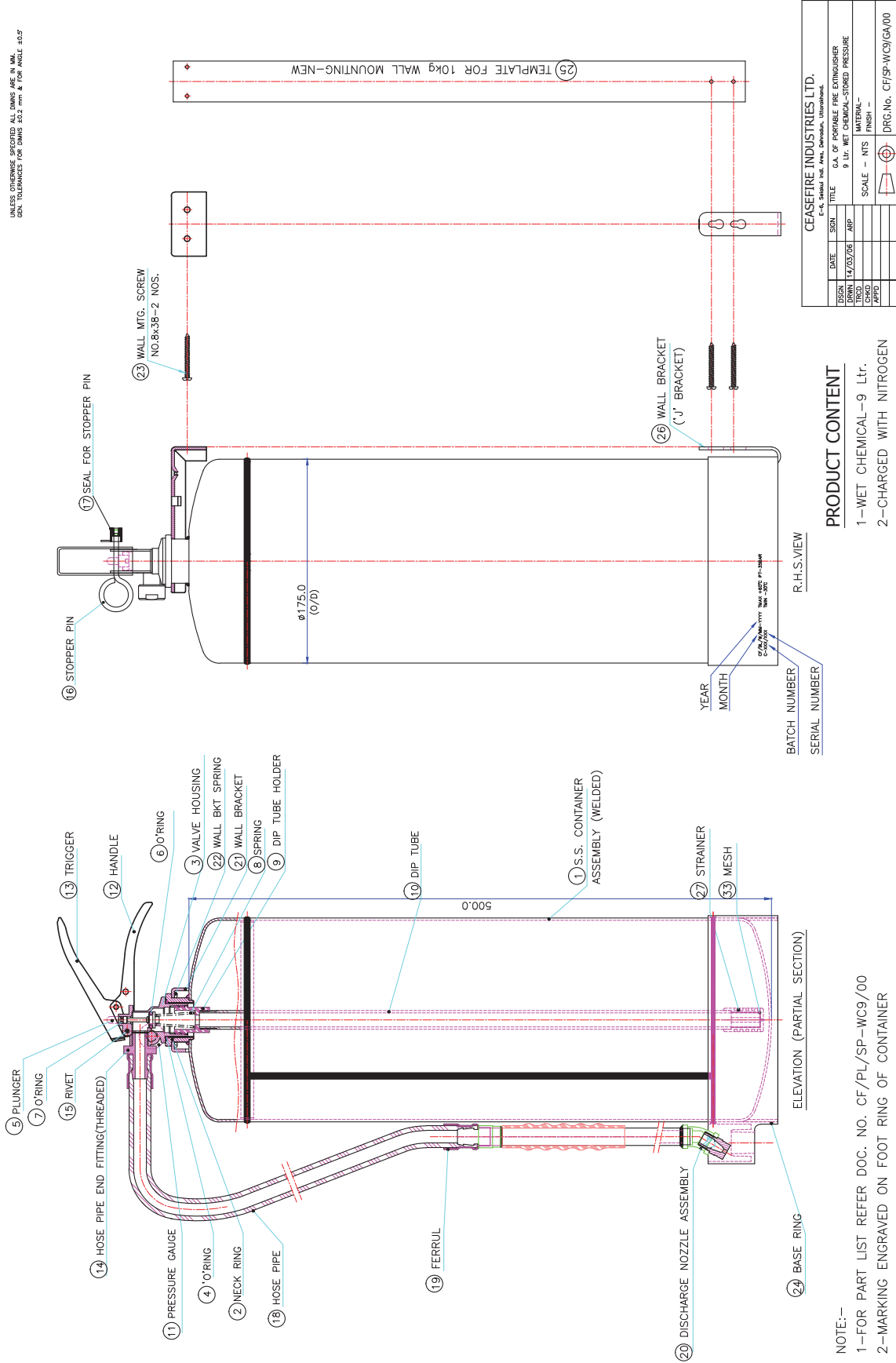

The logo consists of the words "CEASE" and "FIRE" stacked vertically in a bold, sans-serif font, enclosed within a square border.The text "WORLD SERIES" is displayed in a bold, sans-serif font. Behind the text is a faint, dotted map of the world.

DOMESTIC KITCHEN FIRE SUPPRESSION SYSTEMS

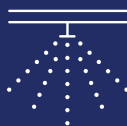

ENVIRO SERIES

WATERMIST BASED DOMESTIC KITCHEN SUPPRESSION SYSTEM

TESTED BY **bsi.**

Ceasefire's domestic kitchen fire suppression system takes care of the aesthetics of your painstakingly curated home.

The detection device, activation nozzles and the agent cylinders are all carefully tucked inside so

HOW THE SYSTEM WORKS:

Ceasefire domestic kitchen firefighting range operates automatically in the event of fire. This removes the risk of a person to fight the fire or even worse fight fire incorrectly.

The system detects fire through its pneumatic heat sensing tube spread through the length of the hood. The tube helps in automatic detection and activation of the suppression system.

On coming in contact with fire the HST ruptures at a pre-determined temperature, creating a pressure differential in the system valves, activating the system. Watermist is used as an extinguishing agent. Being a clean and green extinguishing agent there is minimal post fire damage and the kitchen can be wiped

that the components of the system blends in the current scheme of things in the area of application, without clashing with the décor of the kitchen.

clean. Watermist does not cause any damage; either to the expensive kitchen equipment or food items.

The extinguishing agent is discharged out of the specialized nozzles ensuring effective & efficient firefighting.

The system is adept in handling all kinds of kitchen fires like fires arising due to deep frying, shallow frying, baking, grilling or roasting et al.

On coming with contact with fire the watermist converts into steam. Steam blocks the oxygen supply and brings the temperature to below combustion levels thereby, extinguishing the fire.

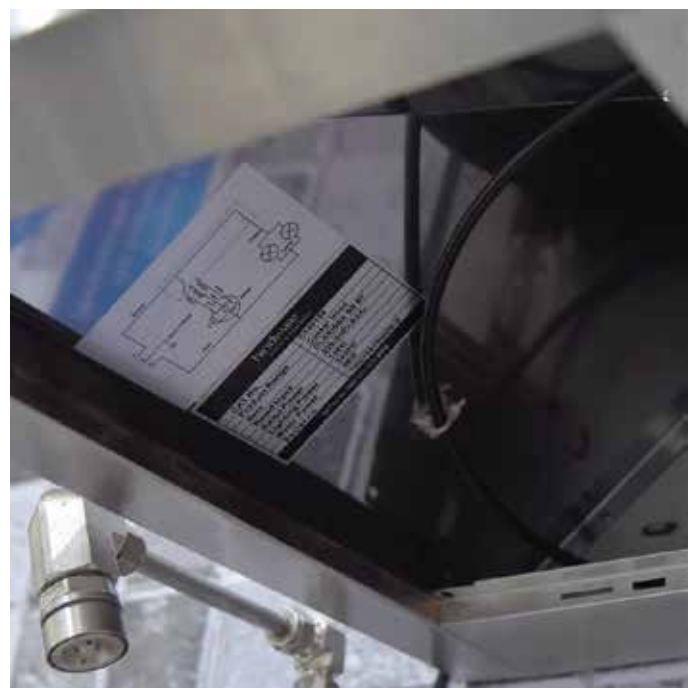

The Ceasefire Watermist Based Domestic Kitchen Fire Suppression System (Enviro Series) comes in two variants in order to address the challenges of a wide variety of kitchen hoods at homes. These two variants are:

VARIANTS AVAILABLE

1. The 3 Litre, 2 Nozzles Variant

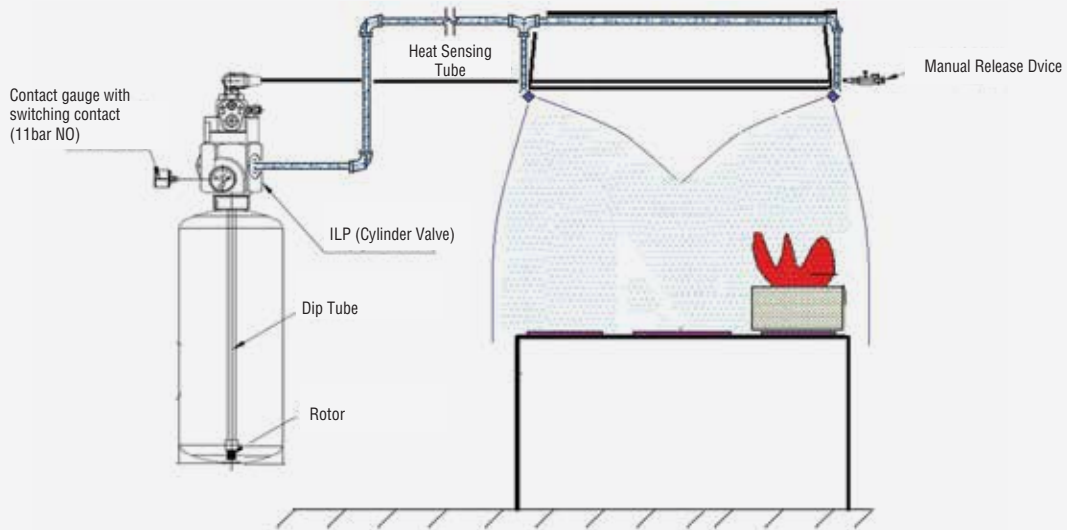

2. The 4.5 Litre, 3 Nozzles Variant

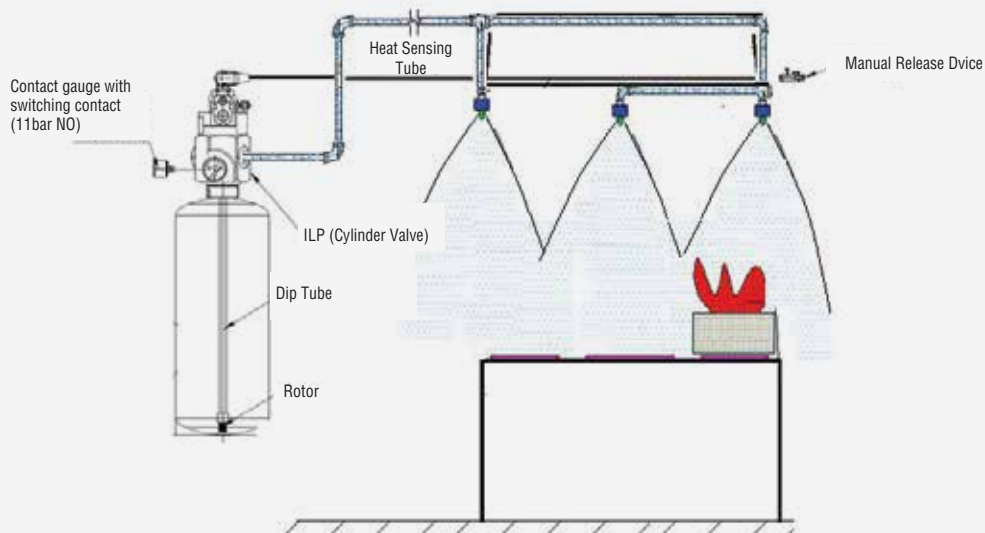

The system is covered with a 12 months warranty, given that periodical maintenance is done by the authorized Ceasefire representative.

Key Components Of The System

SUPPLY UNIT

It is based on rotor units placed inside cylinders filled with filtered water and gas (air or nitrogen). The rotors are designed to produce a medium pulse flow of extinguishing agent and the propellant.



CYLINDER VALVE

The valve is the most crucial component of the suppression system. In case of fire the pressure in HST drops, opening the valve outlet. This in turn expels the extinguishing agent through a separate discharge line.



HEAT SENSING TUBE

The system's detection is based on pneumatic heat sensing tube. The tube is made of high grade polymer plastic. When the tube comes in contact with fire, it bursts open (does not melt) at a pre-determined rate, actuating the system.



MANUAL ACTUATOR

Manual actuator is a manual trigger to activate the system. It is installed in or at the end of the detection line. If actuated, it manually simulates and bursts the heat sensing tube. To actuate the manual trigger simply pull the safety pin and press the red strike knob!



EXTINGUISHING NOZZLES







Ceasefire uses CSFH (Circle Single Fluid Head), a specialised watermist nozzle with a special cap which protects the nozzles from grease and dust.



CEASEFIRE'S DOMESTIC WATERMIST BASED KITCHEN SUPPRESSION SYSTEM GIVES YOU MORE

- Quick and easy installation.
- Extinguishing system designed exclusively for kitchen fires at home.
- No collateral damage thanks to Watermist.
- Works on class A, B and F (cooking oil) fires.
- Maximum extinguishing efficiency, as the Watermist is dispersed over a large surface.
- Minimal maintenance.
- Easy clean up after activation.

Features of Domestic Watermist Based Kitchen Suppression System

	24-hour cook-top fire guard - Automatic detection and actuation controls ensure fire protection is always 'up'.
	Multiple Triggers - The system can be triggered either by the manual actuation system or the automatic detection system.
	Highly Effective - Watermist prevents re-ignition by cooling down the temperature of the heated oil.
	No Collateral Damage - Watermist being a clean agent does not cause any harm to kitchen or equipments.
	Unobtrusive Design - The system components camouflages into the current design of kitchen.
	Highly Reliable - Adapted from Ceasefire's LPCB certified commercial kitchen suppression systems.
	Highly Flexible - Available in a variety of sizes that can be customised as per the application.
	2 Variants - Available in two variants - <u>The 3 Ltrs, 2 Nozzles Variant</u> and <u>The 4.5 Ltrs, 3 Nozzles Variant</u> .



APPLICATION AREAS

The Ceasefire Watermist Based Domestic Kitchen Suppression System is ideal for application in:



Apartments and High Rise Dwellings.



Villas & Independent Houses.



Small Restaurants.



PG Accomodations & Guest Houses.

ULTRA PLUS SERIES

WET CHEMICAL BASED DOMESTIC KITCHEN SUPPRESSION SYSTEM

TESTED BY **bsi.**

The Ceasefire Wet Chemical Based Kitchen Fire Suppression System- Ultra Plus Series

HOW THE SYSTEM WORKS:

The chimney is covered with the pneumatic Heat Sensing Tube (HST). On coming with contact with fire, HST burst open at a pre-determined temperature.

This leads to a drop of pressure which signals

ABOUT WET CHEMICAL AS AN AGENT:

Wet Chemical is a chemical foaming agent that is ideal to fight Class A, B and fires arising in the kitchen. The foam is an environment friendly agent. It is 99% biodegradable (up to 72% within three days).

The wet chemical has a blanketing effect on the flames which cool the super heated oil to below its self-ignition point. Unlike the Class B

incorporates both manual and automatic protection by a pneumatic detection and actuation technique.

the indirect valve thereby activating the system. The strategically placed nozzles disperse the extinguishing agent evenly over the entire cook top area ensuring no blind spots during fire fighting.

fires (where the ignition point of fuels is low) cooking oils burn up at extremely high temperatures to the tune of 350° C-380° C.

Wet Chemical is an ideal agent to address the peculiar challenges in kitchen fire fighting.



The Domestic Kitchen Fire Fighting Range-Ultra Series comes in 2 variants.

VARIANTS AVAILABLE

1. 1 Litre variant with 1 Nozzle

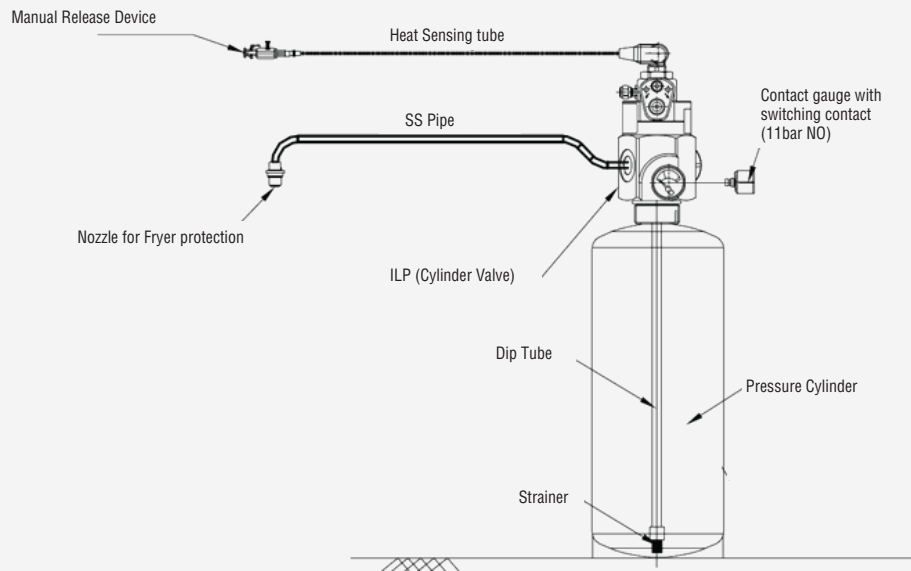

2. 1 Litre Variant with 2 Nozzles

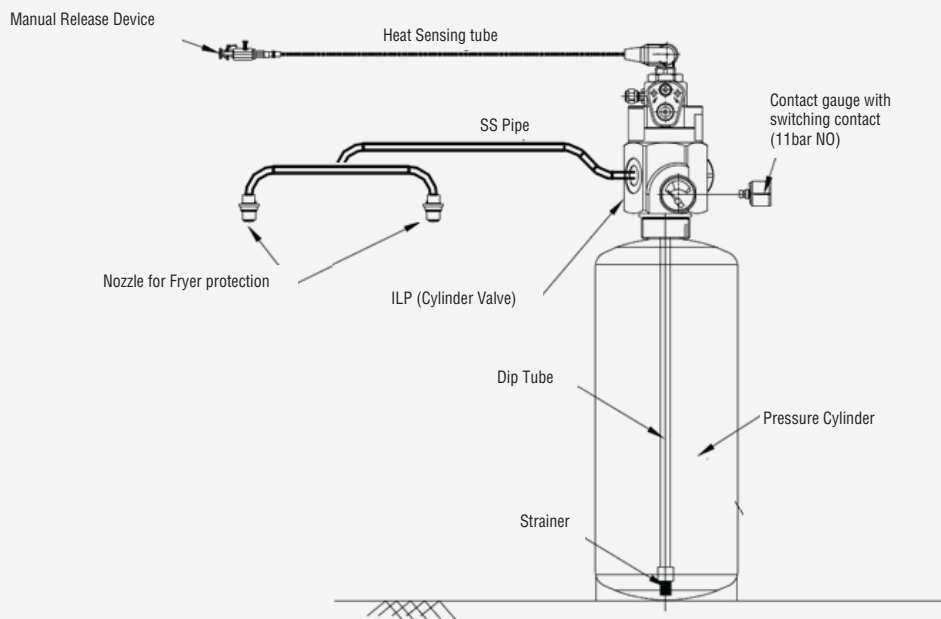

The system is covered with a 12 months warranty, given that periodical maintenance is done by the authorized Ceasefire representative.

Key Components Of The System

SUPPLY UNIT

The stored pressure cylinders are filled with wet chemical and gas (air or nitrogen). The rotors are designed to produce a medium pulse flow of extinguishing agent and the propellant.



CYLINDER VALVE

The Cylinder valve is a key component of the system that corresponds between the detection line (HST) and the agent discharge line. The valve activates the system the moment pressure drops in the detection line.

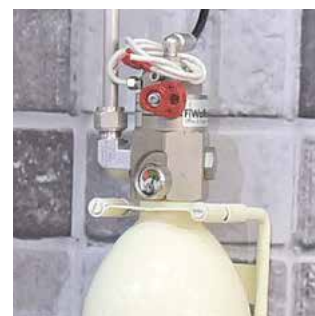

HEAT SENSING TUBE

The system's detection is based on pneumatic heat sensing tube. The tube is made of high grade polymer plastic. When the tube comes in contact with fire, it bursts open (does not melt) at a pre-determined rate, actuating the system.



MANUAL ACTUATOR

Manual actuator is a manual trigger to activate the system. It is installed in or at the end of the detection line. If actuated, it manually simulates and bursts the heat sensing tube. To actuate the manual trigger simply pull the safety pin and press the red strike knob!



EXTINGUISHING NOZZLES









The nozzles are specially designed and strategically placed across the chimney so that the extinguishing agent is dispersed efficiently across cook top. This ensure there are no blind spots in fire fighting.



CEASEFIRE'S DOMESTIC WET CHEMICAL BASED KITCHEN SUPPRESSION SYSTEM GIVES YOU MORE

- Quick and easy installation.
- Extinguishing system designed exclusively for kitchen fires at home.
- Works on class A, B and F (cooking oils) fires.
- Minimal maintenance.
- Environmental friendly; does not produce hazardous by-products.

Features of Domestic Wet Chemical Based Kitchen Suppression System

	24-hour cook-top fire guard - Automatic detection and actuation controls ensure fire protection is always 'up'.
	Multiple Triggers - The system can be triggered either by the manual actuation system or the automatic detection system.
	Highly Effective - Wet chemical agent prevents re-ignition by cooling down the temperature of the heated oil.
	No Collateral Damage - Extinguishing agent doubles up as a cleaning agent after use.
	Unobtrusive Design - The system components camouflages into the current design of kitchen.
	Highly Reliable - Adapted from Ceasefire's LPCB certified commercial kitchen suppression systems.
	Automatic Fire Suppression - Requires no human activation
	2 Variants - Available in two variants - 1 Litre variant with 1 Nozzle and 1 Litre variant with 2 Nozzles.



APPLICATION AREAS

The Ceasefire Wet Chemical Based Domestic Kitchen Suppression System is ideal for application in:



Apartments and High Rise Dwellings.



Villas & Independent Houses.



Small Restaurants.



PG Accomodations & Guest Houses.

CEASE
FIRE

WORLD SERIES

WATERMIST, FOAMMIST
& WET CHEMICAL
BASED EXTINGUISHERS





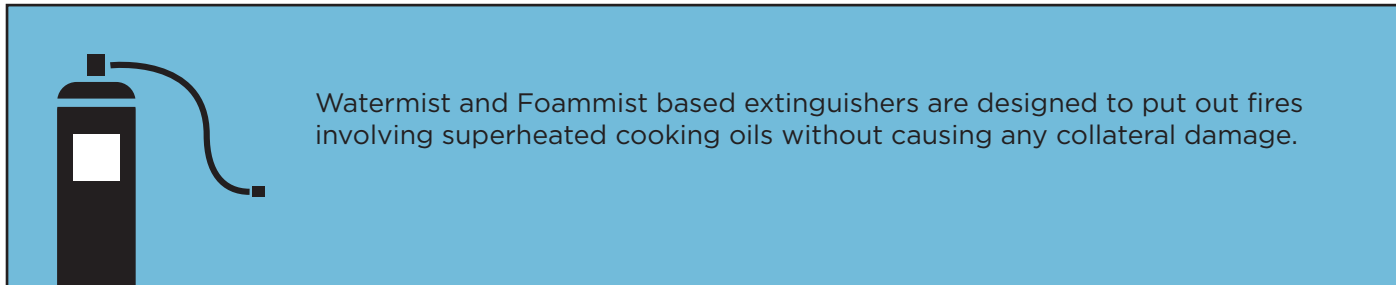

WATERMIST & FOAMMIST BASED PORTABLE EXTINGUISHERS



Watermist based portable extinguisher for kitchens is adept in handling all types of kitchen fires. Once triggered, a specially designed rotary within the mist generator mixes air and water in a pre-set proportion to generate Watermist. The mist is then propelled at the fire through the specially designed nozzle, and has a throw of 10 feet. The mist quickly blankets the flames and brings down the temperature to below combustion levels.

The foammist variant has a foam additive that blankets the flames and cuts off the oxygen supply killing the fire instantly.

The is perfect for every stage of the food chain: production, storage, transportation and distribution.

FEATURES	
	Stainless Steel Body - No corrosion; and can handle high temperatures.
	Can be used on Class F Fires - Fights Class A, B and F (oil) fires.
	No Collateral Damage - The watermist based extinguisher uses distilled water & converts it into a fine mist, ensuring no damage.
	Watermist Available in four variants - 2 liters, 3 liters, 6 liters and 9 liters. Foammist Available in two variants - 2 liters and 6 liters.

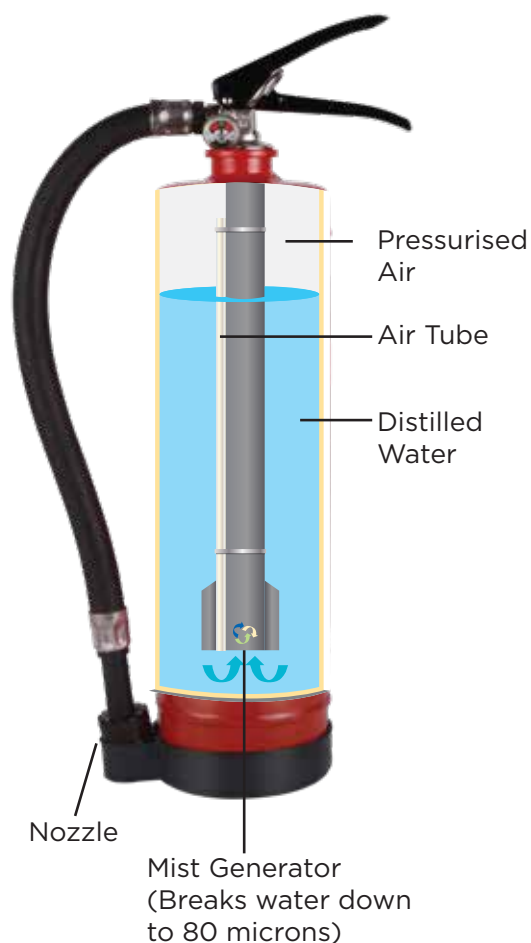

TECHNICAL SPECIFICATIONS:

Nomenclature For Portable Fire Extinguisher	Fire Ext. Watermist 2L SS SP Red	Fire Ext. Foammist 2L SS SP Red	Fire Ext. Watermist 3L SS SP Red	Fire Ext. Foammist 6L SS SP Red	Fire Ext. Watermist 6L SS SP Red	Fire Ext. Watermist 9L SS SP Red
Stored Pressure / Cartridge	Stored Pressure	Stored Pressure	Stored Pressure	Stored Pressure	Stored Pressure	Stored Pressure
Agent	Water	Telesolve1%	Water	Telesolve1%	Water	Water
Agent Category	Watermist	Foammist	Watermist	Foammist	Watermist	Watermist
Product Code	CF-000709	CF-000696	CF-000710	CF-000698	CF-000711	CF-000712
Certification Type	EN-3, PED	EN-3, PED	EN-3, PED	EN-3, PED	EN-3, PED	EN-3, PED
LPCB	Yes	Yes	Yes	Yes	Yes	Yes
Kitemark	Yes	Yes	Yes	Yes	Yes	Yes
PED	Yes	Yes	Yes	Yes	Yes	Yes
MED	No	No	No	Yes	Yes	Yes
Gross Weight	4.45 to 4.65 kg	4.45 to 4.65 kg	Approx. 5.74 kg	10.30 to 10.90 kg	10.30 to 10.90 kg	14.05 to 14.95 kg
Net Mass	1.90 to 2.00 Ltr	1.90 to 2.00 Ltr	Approx. 3 Ltr	5.70 to 6.00 Ltr	5.70 to 6.00 Ltr	8.55 to 9.00 Ltr
Approx. Height Of Fire Ext.	485 mm	485 mm	N/A	575 mm	575 mm	690 mm
Discharge Mechanism	Squeeze Grip	Squeeze Grip	Squeeze Grip	Squeeze Grip	Squeeze Grip	Squeeze Grip
Applicable On Fires	A, F & Electrical Started Fire	A, B, F & Electrical Started Fire	A, F & Electrical Started Fire	A, B, F & Electrical Started Fire	A, F & Electrical Started Fire	A, F & Electrical Started Fire
EN 3 Ratings Class A Fire	5A	5A	8A	13A	13A	21A
EN 3 Ratings Class B Fire	N/A	55B	N/A	144B	N/A	N/A
EN 3 Ratings Class F Fire	25F	25F	25F	40F	75F	75F
Can Construction	Drawn Rolled And MIG Welded	Drawn Rolled And MIG Welded	Drawn Rolled And MIG Welded	Drawn Rolled And MIG Welded	Drawn Rolled And MIG Welded	Drawn Rolled And MIG Welded
Valve / Cap Construction	Forging And Machining	Forging And Machining	Forging And Machining	Forging And Machining	Forging And Machining	Forging And Machining
Internal Coating	No	N/A	No	No	No	No
External Coating	Epoxy Polyester Powder	Epoxy Polyester Powder	Epoxy Polyester Powder	Epoxy Polyester Powder	Epoxy Polyester Powder	Epoxy Polyester Powder
Helium Leak Detection Testing	Yes	Yes	Yes	Yes	Yes	Yes
Warranty In Years	5	5	5	5	5	5
G.A. Drawing Number	CF/SP-WM2LB/GA/02	CF/SP-WM2LB/GA/02	CF/SP-WM3LB/GA/02	CF/SP-FM6LB/GA/02	CF/SP-WM6LB/GA/02	CF/SP-WM9LB/GA/01
Working Pressure	15Bar	15Bar	15Bar	15Bar	15Bar	15Bar
Dia. Of Shell (OD)	108.0 mm	108.0 mm	140 mm	175 mm	175 mm	175 mm
Operating Temperature	5° C to 60°C	5° C to 60°C	5° C to 60°C	5° C to 60°C	5° C to 60°C	5° C to 60°C
Hydrostatic Test Pressure	35Bar	35Bar	35Bar	35Bar	35Bar	35Bar
Cylinder Material Spec.	SS 304 (1.4301)	SS 304 (1.4301)	SS 304 (1.4301)	SS 304 (1.4301)	SS 304 (1.4301)	SS 304 (1.4301)
Body Thickness	1.5 mm	1.5 mm	1.5 mm	1.5 mm	1.5 mm	1.5 mm





* Please check the product specifications at the time of placing your order from our website (address of which is given at the end of this catalogue). Specifications can change without notice due to our continuous R&D and product improvisation initiatives.

WET CHEMICAL BASED PORTABLE EXTINGUISHERS

Ceasefire's wet chemical based fire extinguishers are specially designed to fight oil fires in kitchens. When set against a fire, the specialised foam extinguishing agent in these extinguishers smothers the fire by cutting off the oxygen supply and bringing the surrounding temperature to below combustion levels within seconds. Being a de-greasing substance, the extinguishing agent ensures that the kitchen can be cleaned easily post a fire. Besides, the wet chemical foam is over 99% biodegradable, making these extinguishers safe for the environment.



FEATURES

	Stainless Steel Body - No corrosion; and can handle high temperatures.
	Can be used on Class F Fires - Fights Class A, B and F (cooking oil) fires.
	Prevents re-ignition - The Wet Chemical-based extinguisher is highly effective as it prevents re-ignition.
	Controllable discharge mechanism - A simple squeeze grip activation mechanism allows you to control the discharge of the extinguishing agent.
	Three variants - Available in three variants - 3 liters, 6 liters and 9 liters.

TECHNICAL SPECIFICATIONS:

Nomenclature For Portable Fire Extinguisher	Fire Ext. Wet Chemical 3L MS SP Red	Fire Ext. Wet Chemical 6L MS SP Red	Fire Ext. Wet Chemical 9L MS SP Red	Fire Ext. Wet Chemical 3L SS SP Red	Fire Ext. Wet Chemical 6L SS SP Red	Fire Ext. Wet Chemical 9L SS SP Red
Stored Pressure / Cartridge	Stored Pressure	Stored Pressure	Stored Pressure	Stored Pressure	Stored Pressure	Stored Pressure
Agent	Class F Foam	Class F Foam	Class F Foam	Class F Foam	Class F Foam	Class F Foam
Agent Category	Wet Chemical	Wet Chemical	Wet Chemical	Wet Chemical	Wet Chemical	Wet Chemical
Product Code	CF-000800	CF-000801	CF-000802	CF-000780	CF-000719	CF-000720
Certification Type	EN-3, PED	EN-3, PED	EN-3, PED	EN-3, PED	EN-3, PED	EN-3, PED
LPCB	Yes	Yes	Yes	Yes	Yes	Yes
Kitemark	Yes	Yes	Yes	Yes	Yes	Yes
PED	Yes	Yes	Yes	Yes	Yes	Yes
MED	No	No	No	Yes	Yes	Yes
Gross Weight	Approx. 7.20 kg	11.90 to 12.50 kg	17.75 to 18.65 kg	Approx. 7.20 kg	12.00 to 12.60 kg	17.15 to 18.05 kg
Net Mass	2.85 to 3.00 Ltr	5.70 to 6.00 Ltr	8.55 to 9.00 Ltr	2.85 to 3.00 Ltr	5.70 to 6.00 Ltr	8.55 to 9.00 Ltr
Approx. Height Of Fire Ext.	435 mm	520 mm	615 mm	435 mm	520 mm	610 mm
Discharge Mechanism	Squeeze Grip	Squeeze Grip	Squeeze Grip	Squeeze Grip	Squeeze Grip	Squeeze Grip
Applicable On Fires	A, F & Electrical Started Fire	A, F & Electrical Started Fire	A, F & Electrical Started Fire	A, F & Electrical Started Fire	A, F & Electrical Started Fire	A, F & Electrical Started Fire
EN 3 Ratings Class A Fire	8A	13A	21A	8A	13A	21A
EN 3 Ratings Class B Fire	N/A	N/A	N/A	N/A	N/A	N/A
EN 3 Ratings Class F Fire	40F	75F	75F	40F	75F	75F
Can Construction	Drawn Rolled And MIG Welded	Drawn Rolled And MIG Welded	Drawn Rolled And MIG Welded	Drawn Rolled And MIG Welded	Drawn Rolled And MIG Welded	Drawn Rolled And MIG Welded
Valve / Cap Construction	Forging And Machining	Forging And Machining	Forging And Machining	Forging And Machining	Forging And Machining	Forging And Machining
External Coating	Epoxy Polyester Powder	Epoxy Polyester Powder	Epoxy Polyester Powder	Epoxy Polyester Powder	Epoxy Polyester Powder	Epoxy Polyester Powder
Helium Leak Detection Testing	Yes	Yes	Yes	Yes	Yes	Yes
Warranty In Years	5	5	5	5	5	5
G.A. Drawing Number	N/A	CF/SP-WCLB/GA/02	CF/SP-WC9LB/GA/02	N/A	CF/SP-WC6LB-SS/GA/01	CF/SP-WC9LB-SS/GA/01
Working Pressure	15Bar	15Bar	15Bar	15Bar	15Bar	15Bar
Dia. Of Shell (OD)	140 mm	160.0 mm	175 mm	140 mm	160.0 mm	175 mm
Operating Temperature	5° C to 60° C	5° C to 60° C	5° C to 60° C	5° C to 60° C	5° C to 60° C	5° C to 60° C
Hydrostatic Test Pressure	35Bar	35Bar	35Bar	35Bar	35Bar	35Bar
Cylinder Material Spec.	Steel CR2 (DC01)	Steel CR2 (DC01)	Steel CR2 (DC01)	Steel CR2 (DC01)	SS 304 (1.4301)	SS 304 (1.4301)
Body Thickness	1.6 mm	1.6 mm	2.0 mm	1.6 mm	1.5 mm	1.5 mm

* Please check the product specifications at the time of placing your order from our website (address of which is given at the end of this catalogue). Specifications can change without notice due to our continuous R&D and product improvisation initiatives.



WORLD SERIES

WHY CEASEFIRE:

What gives Ceasefire's Kitchen Firefighting Range an edge over other players in the industry?

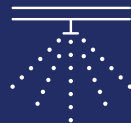

DESIGN & CUSTOMISATION SUPPORT



A Kitchen Fire Suppression System is quite unlike any portable extinguisher.

For one, it can't be purchased off the shelf and put to use. Two, the system needs to be customised, designed and configured to meet the specifications of the space it's being installed in. Three, a wrongly designed system is guaranteed to be ineffective.

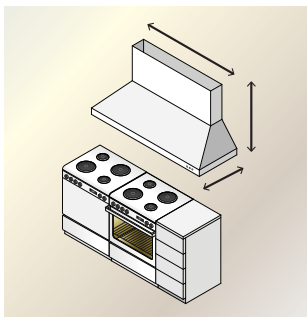

Ceasefire builds customised Kitchen Fire Suppression Systems. Every system's design and configuration is unique depending upon the kitchen it needs to protect.



Ceasefire's Kitchen Fire Suppression System's design is extremely comprehensive.

The system is configured specifically for a given kitchen site, and the installation details are laid out.

These comply with the highest international standards.

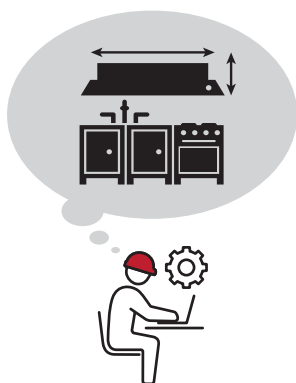

We have a team of specialised, highly experienced engineers and draftsmen who use CAD drawings to design the layout of the heat sensing tubes and nozzles.

Then, pre-determined scientific methods are used to calculate the requirement of extinguishing agent for the kitchen that needs protecting.



THE SYSTEM'S CRITICAL COMPONENTS



- Hooter
- Nozzles
- The Detection Sensor
- Connectors
- Manual Actuator
- Response Panel
- The Valve
- The Extinguishing Agent Container
- The Extinguishing Agent

THE CONTAINER BODY

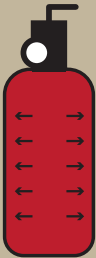

Since the stainless steel container holds the extinguishing agent in a continuous high pressure situation in a harsh kitchen environment, it has to be of a particular quality and thickness.



Ceasefire purchases steel directly from original and reputed producers - Tata Steel, Essar Steel or SAIL.



After mechanically rolling the sheet to form a cylinder shape, the two ends are seamed together by advanced welding technology - Motorised Metal Inert Gas (MIG) CO₂ welding. This motorised technology creates the strongest, smoothest welded seam joint and causes no abrasion while smoothing the seam.

Every single Ceasefire container is:

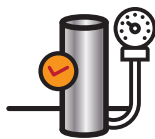

Hydrostatically
Pressure Tested



Chemically treated
against rusting,
flaking and corrosion.



Helium Leak
Tested



To endure extreme
weather conditions.

THE VALVE



In such systems, valves work on the principle of pressure differential, and directly correspond with the Detection Tube and the Discharge Line.

The Indirect Pressure Valve is the system's main component, and is directly involved in the discharge of the agent upon activation.

In case of a fire, the valve senses a drop in pressure in the Detection Line, and allows the extinguishing agent to rush to the nozzles.



Our heavy duty valves are made of high-grade brass/stainless steel which have an integrated Ball Valve feature. This ensures no leakages whatsoever!



The Open/Close switch is designed in such a way that it cannot be accidentally closed. A singular switch regulates the system's ports and only with an allen key can it be accessed. Thus making it 100% safe against being accidentally turned off. The status of the Open/Close knob can be electronically monitored by the Control Panel.



The valves used in Ceasefire's Kitchen Suppression Systems are PED approved and come with inbuilt pneumatic actuation mechanism.

Our superior, specialised manufacturing set up allows for the linking of the Heat Sensing Tube with the cylinder when the valve is closed.



THE DETECTION SENSOR



The functioning of a Kitchen Fire Suppression System depends upon the detection device.

This sensor must do both, detection and activation.

It needs to be critically positioned to cover all the fire prone areas in order to provide linear detection and an un-obtrusive layout. The sensor needs to burst at the right temperature point. If it fails, the system is useless.

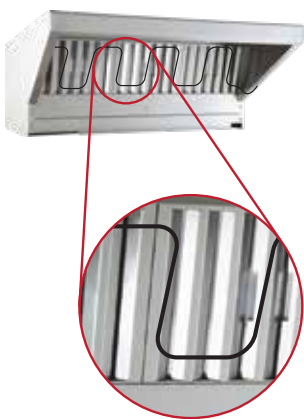

Ceasefire uses advanced Heat Sensing Tube-based superior detection technology. This allows for uniform protection throughout the length of the kitchen hood with linear detection and an un-obtrusive layout.



The Polyamide Heat Sensing Tube with improved burst characteristics acts as a linear heat and flame detector.

The Heat Sensing Tube is UV Protected for a longer life with increased operating temperature, offering robust detection. And with distinct puncture characteristics to actuate the system effectively.

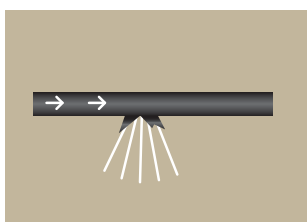

There are no intermediate moving mechanical parts for actuation other than pneumatic pressure itself.

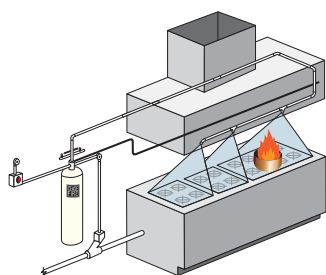

Ceasefire uses a tried and tested LPCB: LPS 1223 approved detection system, which requires no extensive installation and no extensive serviceable parts and minimal down time.

Minimal usage of the tube makes the system less susceptible to pressure drop by reduction of escape area for Nitrogen, thus giving a more robust and stable installation.

THE EXTINGUISHING AGENT



In such systems, valves work on the principle of pressure differential, and directly correspond with the Detection Tube and the Discharge Line.

The Indirect Pressure Valve is the system's main component, and is directly involved in the discharge of the agent upon activation.

In case of a fire, the valve senses a drop in pressure in the Detection Line, and allows the extinguishing agent to rush to the nozzles.



Ceasefire is the only company which offers the option of two variants, based on the kind of extinguishing agents - Watermist and Wet Chemical.

Watermist, as the name suggests, combines water with ground-breaking Watermist technology.

Causes zero contamination

- No collateral damage
- Minimal downtime

Ceasefire's Wet Chemical systems with a special wetting agent.

- That has degreasing and cleaning properties
- Biodegradable

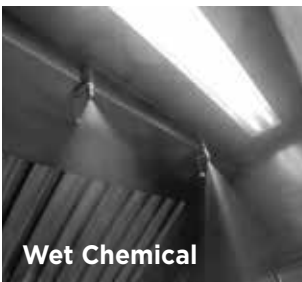

Both technological breakthroughs, the systems are based on advanced heat sensing tube-based detection, offering superior, uniform detection.

The two systems are designed to fight any kind of fire in commercial and industrial kitchens in hotels, restaurants, fast food chains, food courts, catering facilities, schools, religious premises and more.

CONNECTORS



A Kitchen Fire Suppression System is only capable of fighting a fire if it's pressurised. The pressure holding ability of the system is determined by the container, heat sensing tube, valve, and the connectors that join the tubes to the valve and container.



- The connectors used by Ceasefire meet the highest international standards in tightness and pressure holding capacity.
- Each and every connector is thoroughly checked before being installed in the system.



The Heat Sensing Tube and Connectors in Ceasefire Systems are designed to complete the detection and activation line seamlessly, and maintain the pressure throughout the service life of the system - without any flaws.

CONTROL PANEL



Kitchen Fire Suppression Systems need to be electronically monitored to ensure they're ready to come to the rescue.

In larger kitchens with scaled up systems, it's even more essential to have the system in working order.



Ceasefire's In-panel Fire Suppression System comes equipped with a state-of-the-art Control Panel with the ability to monitor up to four cylinder systems.



Plus the provision to monitor the status of each of these four systems' Valve and Pressure Switches.

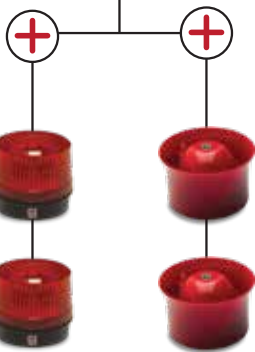

Ceasefire's Kitchen Fire Suppression System comes equipped with a special relay output, that enables the user to install additional Hooters (sound alarms), and Lamp Flashers (visual indicators) on the Detection Line.

They can be installed near the system anywhere depending on the requirements of the premise or the user.

There are total 6 programmable modes on Ceasefire's Control Panels.

- 1. Charging Current
- 2. Zone Naming
- 3. Sense Delay Set
- 4. Relay Switch Type Selection Select
- 5. Pressure Type Select
- 6. Set Password



The Panels have an in built 24-hour battery back up and a user-friendly LCD display.



Spells out the problem in case of activation.



The Panel can be programmed to delay the sounder and relay activation by up to 5 seconds.

NOZZLES



Fitted in the kitchen hood, nozzles play a vital role as they enable effective discharge of the agent.

The nozzles must be designed keeping the extinguishing agent being used in mind, the size of the container, and the length of the kitchen hood.



At Ceasefire, our technologically advanced nozzles ensure enhanced throw, and their strategic positioning rules out any possibility of a blind spot in the kitchen.



Furthermore, the nozzles are designed to fight fires arising from any kind of cooking: deep-frying, grilling, shallow-frying, roasting, sautéing, and more.

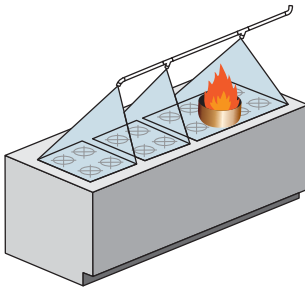

Ceasefire's nozzles ensure:

- Optimum angle of discharge of the extinguishing agent
- The ideal flow rate
- The perfect mixture of air and agent for maximum efficiency.



THE STORED PRESSURE AGENT CONTAINER



The source of the pressure supply in a suppression system plays a vital role in its successful functioning.

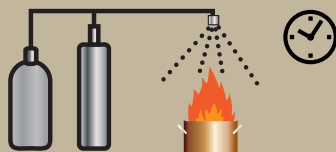

A spot pressure system may cause delays in discharge of the extinguishing agent.

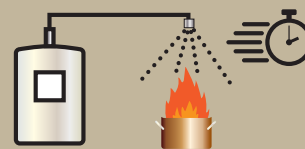

A stored pressure suppression system works within seconds.



Ceasefire's offers only stored pressure Kitchen Suppression Systems in single containers.



Ceasefire's systems are designed with minimum movable parts, so that the system is easy to install.

We offer single containers so that you need just one container, no matter the size of the kitchen.

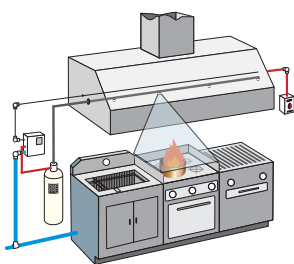

Minimal piping and obtrusion in the kitchen area.

- Minimal space usage of mechanical parts and minimal service requirements.

Ceasefire's systems are built to need minimal modifications, if any, to the kitchen structure. Simplified design parameters allow you the flexibility to position the container wherever you want, without worrying about the clutter of multi-cylinder systems.



Ceasefire's Watermist-based and Wet Chemical-based systems are both stored pressured.

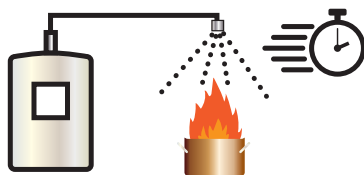

This does away with the hassle of first kicking the cartridge in action, waiting for it to charge before firefighting.

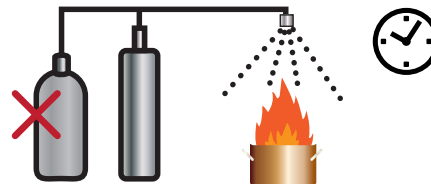

Saving time, and protecting property and lives. Ceasefire has singular direct actuation for supply with no separate actuation units and propellant tank cylinders.

INSTALLATION SUPPORT



One of the most important steps towards ensuring that your system is functioning perfectly, is to make sure that it is installed properly. Even the best designed system with the best quality components can fail if the system is not installed correctly. In short, your system is only as good as the installation.



At Ceasefire, we have a team of trained technical support professionals to install the Kitchen Fire Suppression System. The installation, overlooked by our engineers, meets every standard and guideline set.

SERVICE NETWORK AND SUPPORT



A high-end specialised system requires specialised service support. These systems are complicated, and if the manufacturer of the system cannot provide service support at that location, it can lead to much confusion.

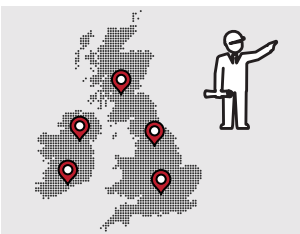

At Ceasefire, we have a direct, nationwide delivery and service network spread across the length & breadth of the country.

CERTIFICATIONS & APPROVALS



With time bound meals continuously going out through the day, kitchens are highly susceptible to fires. A Kitchen Fire Suppression System is a highly specialised system that's under tremendous pressure.

It's therefore essential for such systems to be designed, manufactured and installed according to certified and approved benchmark standards set by competent certification agencies.



LPS 1223
Cert/LPCB Ref. 1329a

The Ceasefire Kitchen Fire Suppression Systems have the British LPCB: LPS 1223 certification for both its Watermist and Wet Chemical variants. These systems have successfully passed the most stringent test criteria laid out by the British certification agency under the category of kitchen fire suppression systems. Which means not one or two components, but the system as a whole is fully certified.



Ceasefire Industries UK Limited,
1 Victoria Square, Birmingham B1 1BD,
United Kingdom

Call our Hotline:
0-113-868-6666 / 0-126-891-9999

www.ceasefire.co.uk

Follow us on:



MARKETED BY:

